



Mining Catalogue

Edition 3

 **SafeSmart**
MINING

A Better Way

Toronto

Regina

Vancouver

1-866 635 8818

Height Access Solutions
safesmartaccess.ca

The Global Brand Trusted by Leading Mining Companies Worldwide

SafeSmart is a manufacturer and importer of portable height access equipment. SafeSmart provides height access solutions across Canada, with a world-wide distribution network catering for the construction, defence, mining, aviation, transport and pipeline industries around the globe.

Across all industries, we work closely with clients to design and manufacture custom-built steps, stairs, work platforms and any products that help to increase safety and efficiency on the worksite.

SafeSmart—and our specialist division, Proscaf – has branches in Canada, New Zealand, UK, France, Australia, Chile, Argentina, and the USA. We understand the regulatory requirements for safety compliance in each region, and we design our products around those requirements.

A Better Way

We have the resources and dedicated support teams to stay at the forefront of innovation in the demanding world of height access.

From our in-house design experts to our advanced production and independent certification processes, our can-do approach ensures we work closely with you to solve challenges, improve safety, and streamline workplace efficiency.



01

Standard Products

Pages 6 - 27

Ready-to-go solutions for safe height access and edge protection on vehicles and machinery.



02

Open Pit Solutions

Pages 29 - 53

Tailored access platforms for dozers, haul trucks, and loaders, designed to simplify maintenance and improve safety.

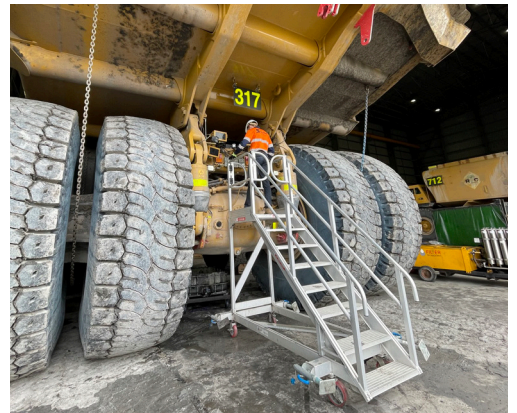

03

Underground Solutions

Pages 55 - 61

Custom built height access systems designed for safe and efficient maintenance of underground equipment.

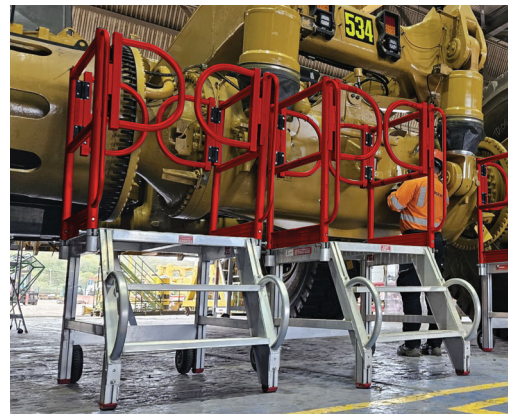

04

Plant Maintenance

Pages 62 - 77

Flexible systems to provide safe and efficient height access around workshops and mine sites.

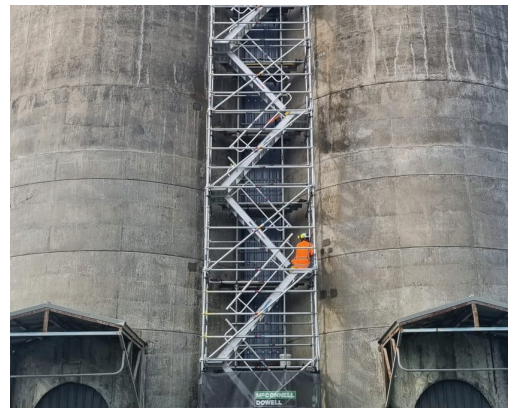

Scaffold Eating up too much of your Budget?

Scaffolding is a necessary part of any mining project, but it doesn't have to break the bank.

At SafeSmart, we understand the challenges of shutdowns and maintenance work. That's why we offer Scaffold Reduction Audits—designed to help you cut costs, improve efficiency, and work smarter.

Our team conducts onsite reviews of your current scaffolding setup, identifying opportunities where safer, more practical work platforms can be used instead. By collaborating closely with your site team, we ensure every recommendation aligns with the specific needs of the job.

The goal: minimize scaffolding, maximize safety, and streamline your onsite access.

Simple 4-Step Process

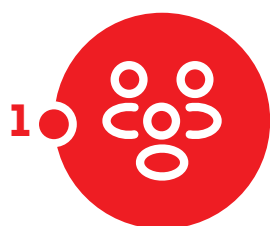

Engage with
on-site teams



Scope and
audit



Review
existing process



Evaluation &
solution proposal

Advantages of Completing a Site Audit

- **Lower contract load** – Limit subcontracting to complex access applications requiring scaffolding.
- **Reduced on-site risk** – Fewer personnel and less manual labour on site.
- **Less scaffolding required** – Minimize structures and reduce onsite tonnage.
- **Optimised work processes** – Simplified and efficient access and installation methods.
- **Leaner crews** – Reduce tasks from 3–4 people to just 1–2.

Taking site constraints and conditions into account, SafeSmart delivers practical, custom solutions—from bespoke work platforms to alternative access systems—designed specifically for each work area.

After the review, your site team receives a detailed proposal outlining each area and scaffolding structure identified in the audit, along with a direct alternative solution. This may include a made-to-order design or ready-to-go, off-the-shelf systems.

All solutions are designed to work within space limitations while ensuring efficient, safe access, without compromising budget or ease of manual handling.



Scan Code
Request a Scaffold
Reduction Audit





Section 01

Standard Solutions

Warthog Platform Ladder	6
Branach Ladders	8
Platforma Ladders	9
Super Maintenance Platform	10
Super Service Stand	14
Super Steps	16
Cantilever Platform	17
EasyRaise Platform	19
ReachDeck Platform	21
UltraRaise Platform	23
BridgeDeck	26
Adjustable Chassis Rail Edge Protection	27

A Better Way

01 Standard Products

Warthog Platform Ladder

Code	Type	Size (Deck Height)
210093	2 Step	0.6m
210094	3 Step	0.9m
210095	4 Step	1.2m
210096	5 Step	1.5m
210097	6 Step	1.8m
210098	7 Step	2.1m
210099	8 Step	2.4m
210100	9 Step	2.7m
210101	10 Step	3.0m
210201	Spring Loaded Caster (ea)	
210128	Full Surround Safety Rail	

- 10-year manufacturer's warranty.
- Fully welded box section aluminum frame.
- Won't twist like a standard platform ladder.
- Platform kick board stops slips & spills.
- Large comfortable platform & handrail for longer duration work.
- Folds flat for storage & transportation.



180kg
WLL

Complies with
Canadian OH&S

10 Year Wear &
Tear Guarantee



01 Standard Products

Warthog Platform Ladder

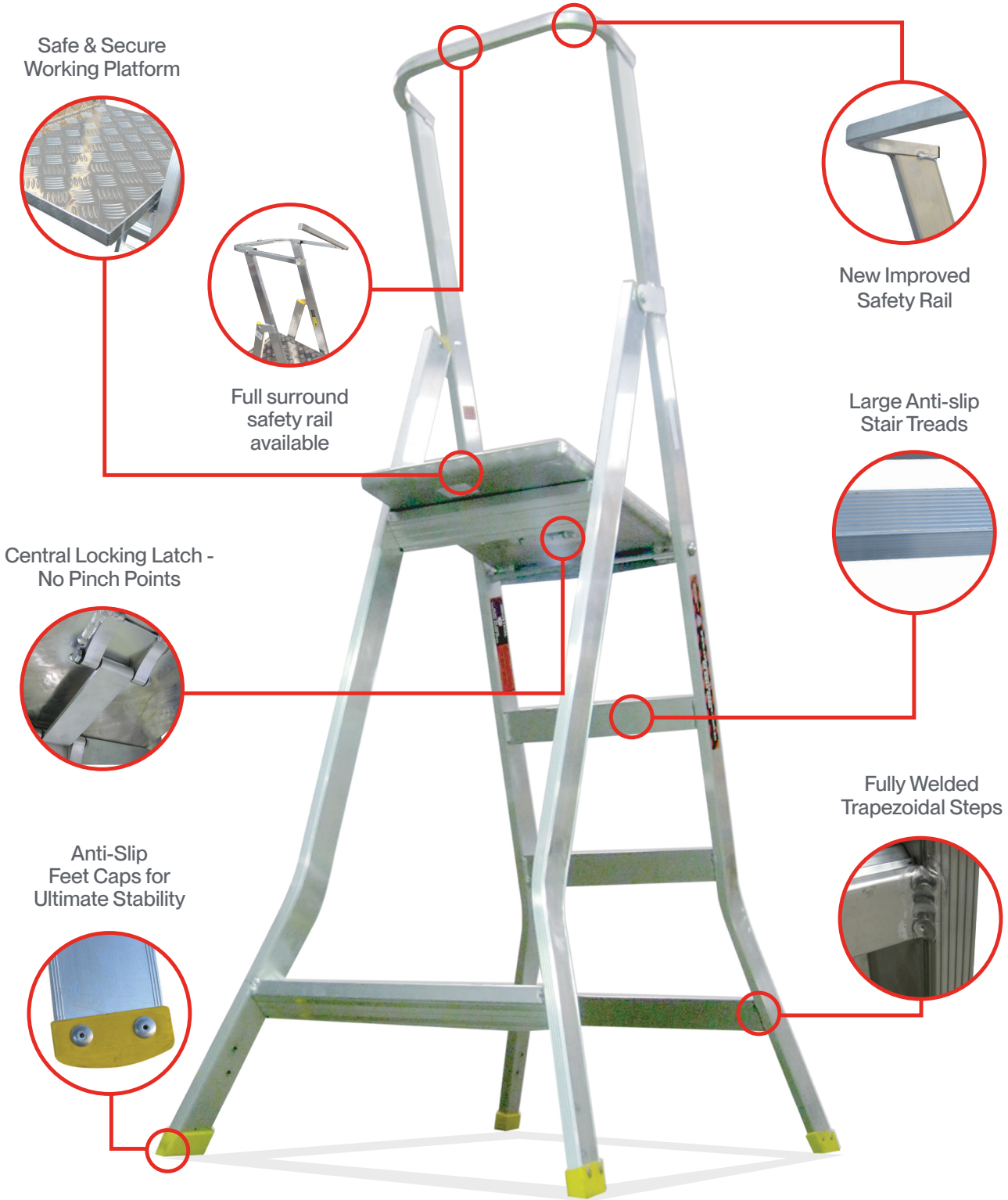

01 Standard Products

Fibreglass FPL Series

Code	Type	Deck Height
210336	2 Step	0.6m
210356	3 Step	0.9m
210317	4 Step	1.2m
210318	5 Step	1.5m
210319	6 Step	1.8m
210320	8 Step	2.4m
210321	10 Step	3.0m
210322	12 Step	3.6m

- Sturdy & durable.
- Lightweight design for ease of access.
- Single action set-up.
- Comfortable, non-restrictive 450mm wide platform.
- Non-slip hinged aluminum platform.
- Rubber feet.
- Optional back rail for all round protection.



150kg
WLL

Electrically Safe
Fibreglass



01 Standard Products

Platforma Ladders

Code	Platform Height	Ladder Length
15TPLF03-05	0.8m - 1.4m	1.9m - 2.4m
15TPLF03-07	1.1m - 2m	2.3m - 3.1m
15TPLF03-09	1.4m - 2.6m	2.5m - 3.5m

- Platform height adjustable in seconds!
- Up to 4 ladder models in one unit.
- Stable on uneven ground.
- Type 1A rating.

135kg
WLL

Complies with
Canadian OH&S



SafeSmart

Full surround cage
The guardrail saves operators having to tie off and frees both hands while safely working on the ladder.

Tilting handrail
For easier storage.

Gripped aluminium platform
Comfortable work area with toe kick to ensure feet and materials are kept within the platform.

Easy fold platform
Gravity locking systems make it easy to fold and unfold the standing platform.

Tilt and roll casters
Provides easy repositioning and manoeuvrability.

Locking pins
Automatically located and locks into the receiving holes.

Tool bucket (optional add-on)
Clips on the guardrail for convenient tool storage

PLATFORMA™

01 Standard Products

Super Maintenance Platform

Code	Platform Height	Platform Size	Type
210520	565mm	800 x 800mm	2 Step
210521	850mm	800 x 800mm	3 Step
210522	1130mm	800 x 800mm	4 Step
210523	1400mm	800 x 800mm	5 Step
210524	1700mm	800 x 800mm	6 Step
210525	1970mm	1000 x 1000mm	7 Step
210526	2250mm	1000 x 1000mm	8 Step
210527	2540mm	1000 x 1000mm	9 Step
210528	2828mm	1000 x 1000mm	10 Step
210529	3100mm	1000 x 1000mm	11 Step
210530	3300mm	1000 x 1000mm	12 Step
210531	3600mm	1000 x 1000mm	13 Step
210532	3950mm	1000 x 1000mm	14 Step

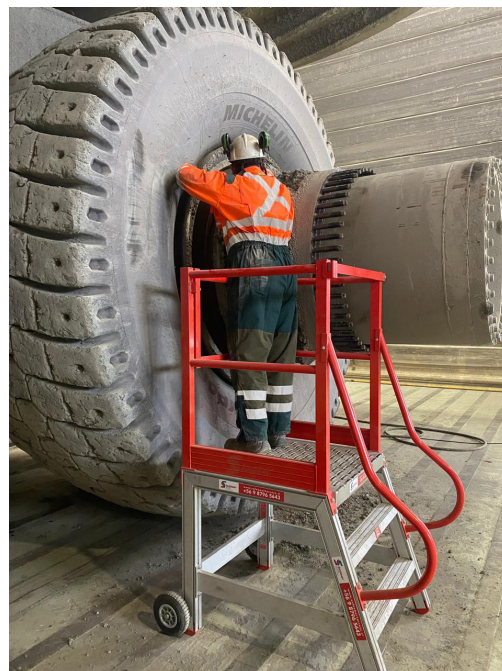

- Engineers' approval, WLL rating & serial number certification plate.
- Built tough with 82 x 50mm marine grade aluminum RHS - no C channel.
- Perforated & swaged deck for superior traction in wet and greasy conditions.

180kg
WLL

Complies with
Canadian OH&S

Load Tested Up to
8 Tonnes

5 Year
Warranty



01 Standard Products

Super Maintenance Platform



Side Exit Gates Available

Rear Safety Bar

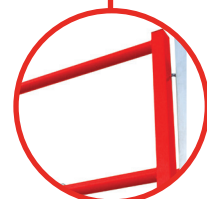

Locking Safety Gate

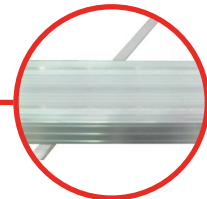

Solid Non-Slip Tread



Ergonomic Lifting Handles



Anti-Slip Rubber Foot

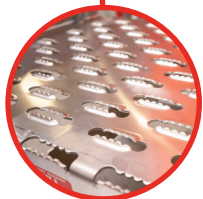

Raised & Swaged 4mm Anti-slip Plate Platform

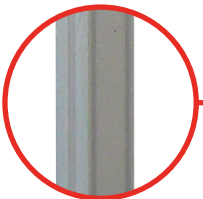

Box Section Aluminum Frame for Ultimate Durability



Anti-puncture Solid Rubber Wheels



01 Standard Products

Super Maintenance Platform - Accessories

Batwing Gates

Code	Description	Type
210770	Batwing Gates	2 - 6 Step
210771	Batwing Gates	7 - 14 Step

- Self-closing Batwing Gate at the entrance of the platform.
- User friendly operation when compared to a traditional bar or non-compliant chain.
- Offers greater protection by providing a safe guardrail and midrail around the stairs entrance.



Fold-out Protection Wings

Code	Description	Type
210834	Fold-out Protection Wings 1.2mL	2 - 6 Step
210849	Fold-out Protection Wings 1.0mL	7 - 14 Step
210889	Fold-out Protection Wings 2.0mL	2 - 6 Step

- Provides extra edge protection beside the platform entrance.
- Folds against side of platform for ease of storage.



Retrofit Side Entry Gate

Code	Description	Type
220121	0.8m Retrofit LH Side Entry Gate Set	2 - 6 Step
220122	0.8m Retrofit RH Side Entry Gate Set	2 - 6 Step
220119	1.0m Retrofit LH Side Entry Gate Set	7 - 14 Step
220120	1.0m Retrofit RH Side Entry Gate Set	7 - 14 Step

- Fits in place of standard side guardrails.
- Provides walk-through access off side of platform.

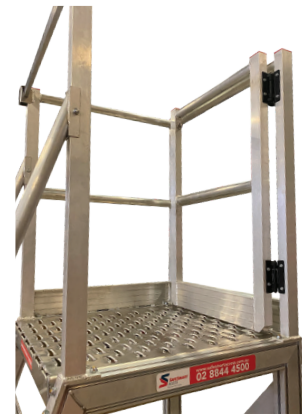

Retrofit Dual Exit Gates

Code	Description	Type
220126	0.8 Retrofit Dual LH & RH Exit Gate w. Fixed End Panel	2 - 6 Step
220127	1.0 Retrofit Dual LH & RH Exit Gate w. Fixed End Panel	7 - 14 Step

- Allows walk-through access off both sides of the platform.



01 Standard Products

Super Maintenance Platform - Accessories

Retrofit Forklift Channel - Set of 2

Code	Description
210291	Retrofit 0.8mL Forklift Channel Set of 2
210292	Retrofit 1.0mL Forklift Channel Set of 2

- Bolts on to platform base.
- Retrofit 0.8mL Forklift channels are suitable for Super Maintenance Platforms up to 6 Steps.
- Retrofit 1.0mL Forklift channels are suitable for Super Maintenance Platforms 7 Steps and above.



125mm Caster Kit - Retrofit

Code	Description
210744	125mm Caster Kit - Retrofit

- Set of 4 bolt-on swivel and locking casters.
- Replaces the existing two wheels on the platform frame.



01 Standard Products

Super Service Stand

Code	Platform Height	Platform Size	Type
210570	550mm	800mmL x 900mmW	2 Step
210571	825mm	800mmL x 900mmW	3 Step
210572	1100mm	800mmL x 900mmW	4 Step
210573	1350mm	800mmL x 900mmW	5 Step
210574	Super Service Stand Guardrail Set - Retrofit Removable Sleeve Guardrails with Self-actuating Batwing entry/exit		2 - 5 Step

- Large, safe work area with self-draining platform surface (for slip resistance in all conditions).
- Wide stair treads for comfort and safety.
- 60° step angle of access.
- Quick release guardrails can be added or removed in seconds.
- Dual Batwing Gates for full surround protection.

180kg
WLL

Complies with
Canadian OH&S

5 Year
Warranty

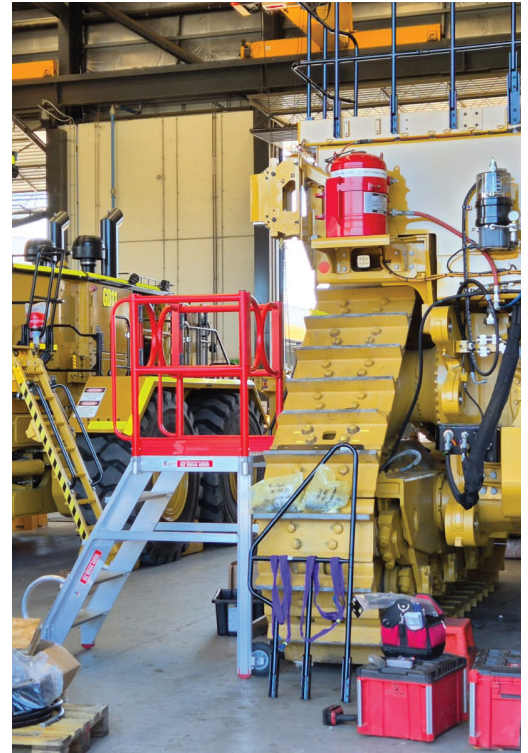

Platform shown
without handrails

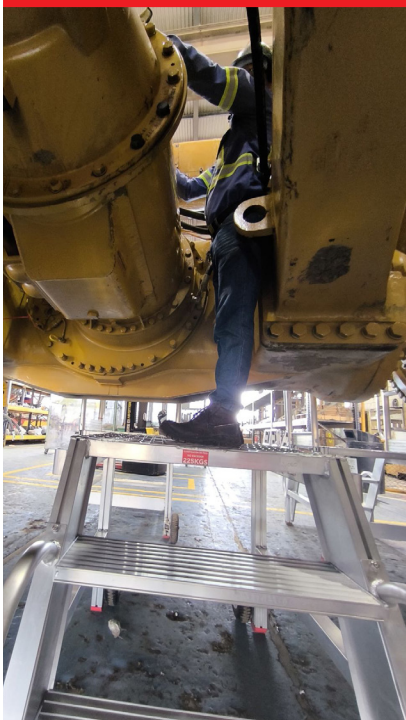

Handles for manoeuvrability,
simply lift to engage the front
wheels.



01 Standard Products

Super Service Stand



Quick-Release Handrails

Raised & Swaged 4mm Anti-slip Plate Platform

Handrails for Maneuverability

Ultra-Wide Step Treads

Heavy-duty Box Aluminum Frame

01 Standard Products

Super Steps

Code	Platform Height	Platform Size	Type
900141	457mm	305mmL x 719mmW	2 Step
900142	686mm	305mmL x 719mmW	3 Step
900143	914mm	305mmL x 719mmW	4 Step

- Self-draining platform surface (for slip resistance in all conditions).
- 60° step angle of access.
- Lightweight for easy movement around service area.

225kg
WLL

Complies with
Canadian OH&S



01 Standard Products

Cantilever Platform

Code	Platform Height	Platform Size	Steps
210540	565mm	800 x 1800mm	2 Step
210541	850mm	800 x 1800mm	3 Step
210542	1130mm	800 x 1800mm	4 Step
210543	1400mm	800 x 1800mm	5 Step
210544	1700mm	800 x 1800mm	6 Step
210545	1970mm	1000 x 2000mm	7 Step
210546	2250mm	1000 x 2000mm	8 Step
210547	2540mm	1000 x 2000mm	9 Step
210548	2828mm	1000 x 2000mm	10 Step
210549	3100mm	1000 x 2000mm	11 Step
210550	3300mm	1000 x 2000mm	12 Step
210551	3600mm	1000 x 2000mm	13 Step
210552	3950mm	1000 x 2000mm	14 Step
210553	7 Step Cantilever Platform 1.0mL Upgrade Kit/Package*		
210554	8 Step Cantilever Platform 1.0mL Upgrade Kit/Package*		
210555	9 Step Cantilever Platform 1.0mL Upgrade Kit/Package*		
210556	10 Step Cantilever Platform 1.0mL Upgrade Kit/Package*		
210557	11 Step Cantilever Platform 1.0mL Upgrade Kit/Package*		
210373	Retrofit Wind Down Jack Set		
210293	Retrofit 0.8mL Forklift Channel Set of 2 (suits up to 6 steps)		
210294	Retrofit 1.0mL Forklift Channel Set of 2 (suits 7 step and above)		

*1.0mL upgrade kits will reduce the protrusion of the base rails, and increase the cantilever to 1009mm clear overhang.

- An essential tool for all machinery service workshops.
- Allows you to get right into and up against your work area without reaching out from the platform.
- Built tough, non-slip perforated deck and aluminum frame.

225kg
WLL

Complies with
Canadian OH&S

5 Year
Warranty

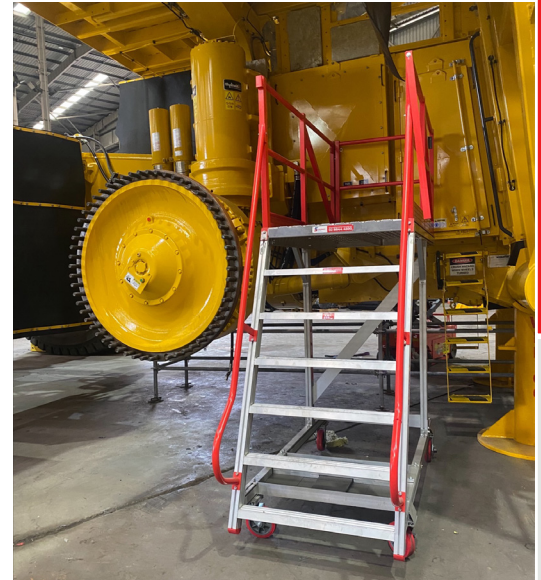

Clearance for Cantilever Platforms

01 Standard Products

Cantilever Platform

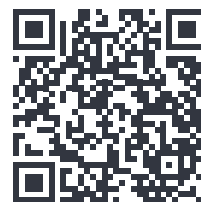

Stair Access
Option Also
Available



Spring-Loaded Latch

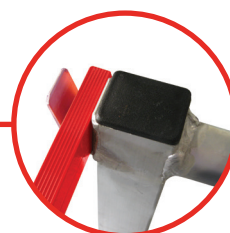

Rear Safety
Bar

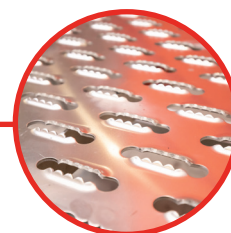

Raised & Swaged
4mm Anti-slip Plate
Platform



WLL & Serial
Number Plate

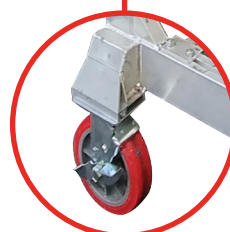

200mm Locking Large
Heavy-duty Casters



01 Standard Products

EasyRaise Platform

Code	Platform Height	Platform Size
220150	1.2 - 2.4m 4 Step	1000 x 1000mm
220151	1.4 - 2.8m 5 Step	1000 x 1000mm
220152	1.7 - 3.4m 6 Step	1000 x 1000mm
220153	1.9 - 3.8m 7 Step	1000 x 1000mm
210103	EasyRaise Retrofit Forklift Channel Set of 2	

Other sizes are also available - please enquire

- Height adjustable platform with manual winch.
- Incrementally adjustable with platform heights at 282mm intervals.
- Compact & mobile for easy deployment.
- Cantilever length increases as the platform is raised.

225kg
WLL

Complies with
Canadian OH&S

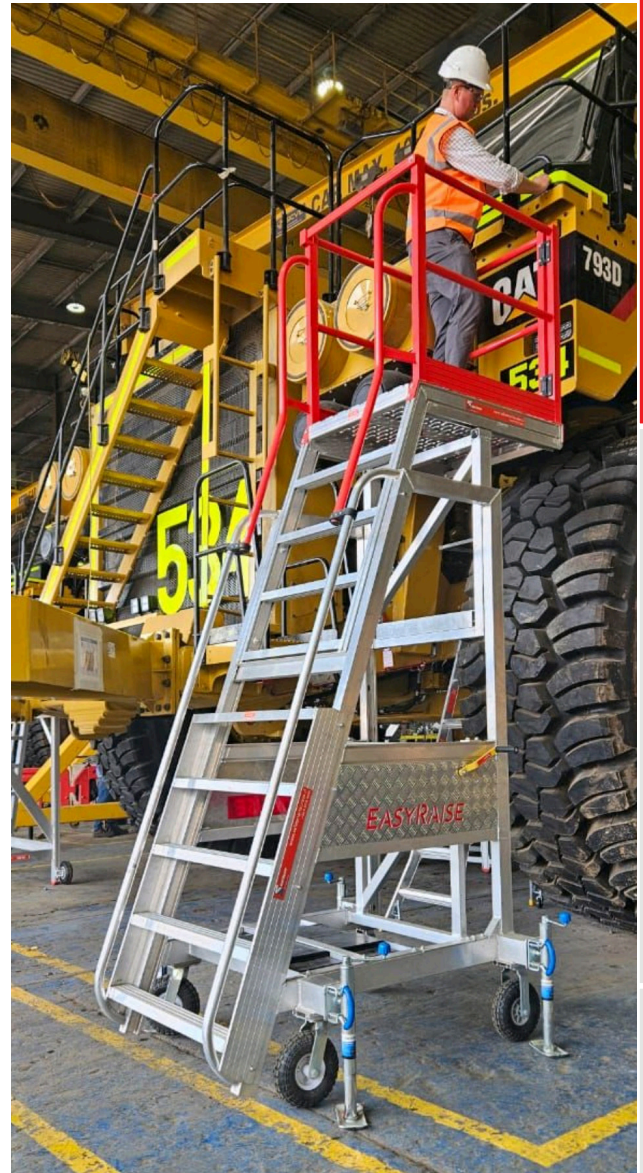

One Platform - 6 Height Settings



EasyRaise 4-Step Platform (210371)



EasyRaise 4-Step Platform (210371)
6 Step Height Adjustment



EasyRaise 4-Step Platform (210371)
8 Step Height Adjustment

01 Standard Products

EasyRaise Platform



"We were looking for an alternative to an EWP and the SafeSmart EasyRaise Platform is perfect for our application. Reduced on-going maintenance costs is very attractive and being able to replace multiple fixed level platforms with one unit has been a bonus"

**— Supervisor,
Hastings Deering**



01 Standard Products

ReachDeck Platform

Code	Description
211100	ReachDeck - 9 Step (2.0mH - 3.15mH)
211101	ReachDeck - 15 Step (3.375mH - 5.4mH)
211102	ReachDeck Platform Only (Small) 0.9mL x 1.05mW
211103	ReachDeck Platform Only (Large) 1.0mL x 2.5mW - Standard Guardrail Frames
211104	ReachDeck Platform Only (XL) 1.4mL x 3.0mW - Aviation Guardrail Frames
210372	SafeWrap Towbar
210378	ReachDeck Retrofit Loop Guardrail Frame (1.2mD x 1.5mW)
210377	ReachDeck Retrofit Loop Guardrail Frame (2.0mD x 2.0mW)
210379	ReachDeck Bridge 3.0mL x 0.6mW with removable Guardrail, Midrail & Toeboard

500kg
WLL

Complies with
Canadian OH&S

- Adjusts in height from 2.0 up to 5.4mH via a manual winch (hydraulic or pneumatic adjustment options also available).
- Crane of air - liftable, for ease of transport offshore (Crane lifting plan included)
- Platform options include fall restraint points, for user safety when stepping out onto larger vehicles.

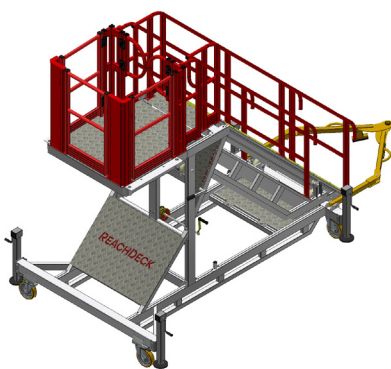

211102
ReachDeck Platform (Small)
0.91mL - 1.05mW with Standard
Guardrail Frames

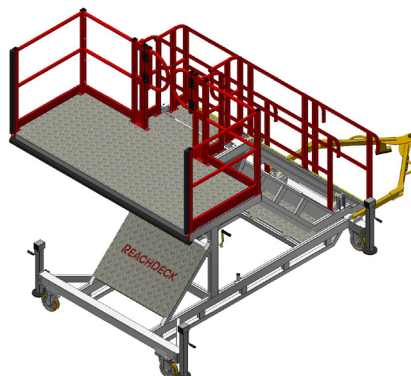

211103
ReachDeck Platform (Large)
1.0mL - 2.5mW with Standard
Guardrail Frames

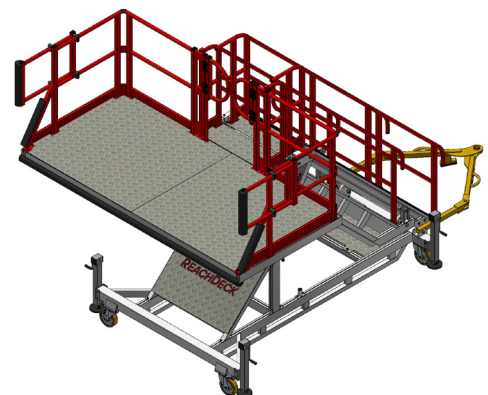

211104
ReachDeck Platform (XL)
2.4mL - 3.0mW with Standard
Guardrail Frames

01 Standard Products

ReachDeck Platform

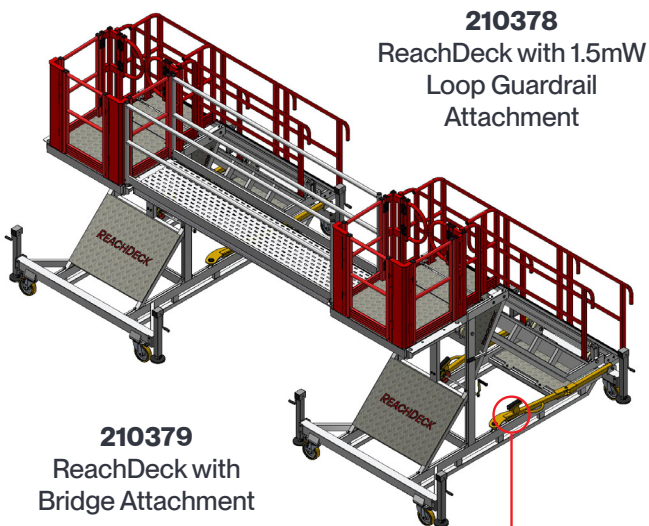
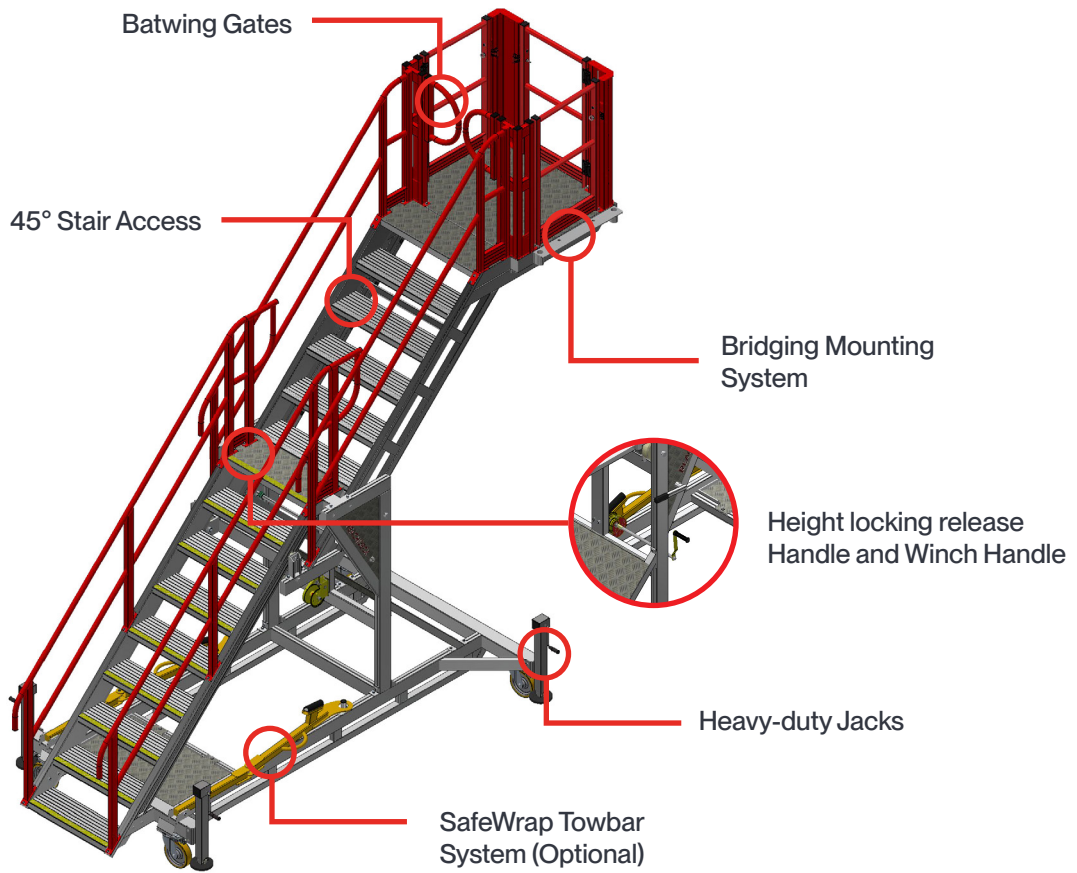

211105
SafeWrap Towbar



01 Standard Products

UltraRaise Platform

Code	Description
210375	7 Step UltraRaise Fixed Cantilever H/Adj Platform 1.97mH – 3.38mH w. 70deg Acc
210376	10 Step UltraRaise Fixed Cantilever H/Adj Platform 2.82mH – 5.07mH w. 70deg Acc
210378	UltraRaise Retrofit Loop Guardrail Frame, 1.2mD x 1.5mW
210377	UltraRaise Retrofit Loop Guardrail Frame, 2.0mD x 2.0mW
210379	UltraRaise Bridge 3.0mL x 0.6mW with removable Guardrail, Midrail & Toeboard (ea side)
210416	UltraRaise 10 Step Accessory - Retrofit Side Mounted Platform 2.245mL x 0.8mW

- Platform height and bridge lengths are customisable.
- Massive height adjustment range!
- Compact and mobile for easy deployment and use in tight workshops.
- 700mm clear cantilever regardless of the height it is set at.
- Height adjustable platform with a manual winch.
- 3 access directions off the platform allowing for flexibility in configuration.
- Bridging attachment to connect between units allows multiple configurations.
- Bridging components no heavier than 17kgs to allow easy install and dismantle.
- Bubble levels to assist with levelling.
- Loop guardrail attachment can be placed in all 3 directions off the platform.
- Loop guardrail support leg adjusts in 25mm increments.

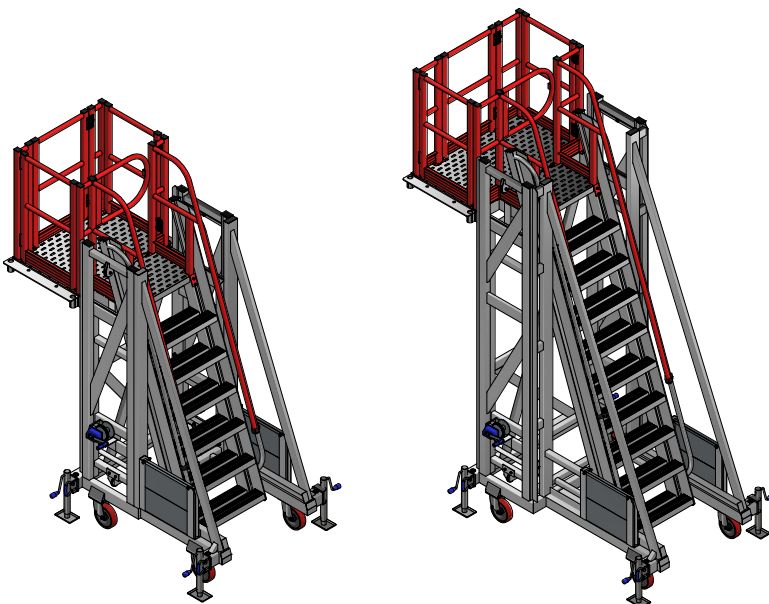
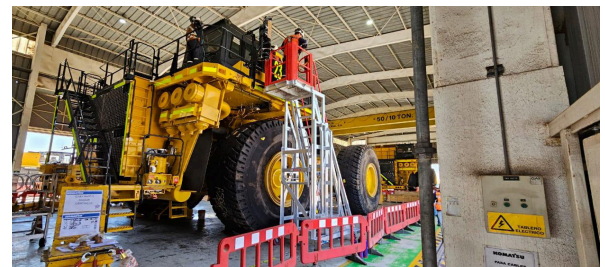
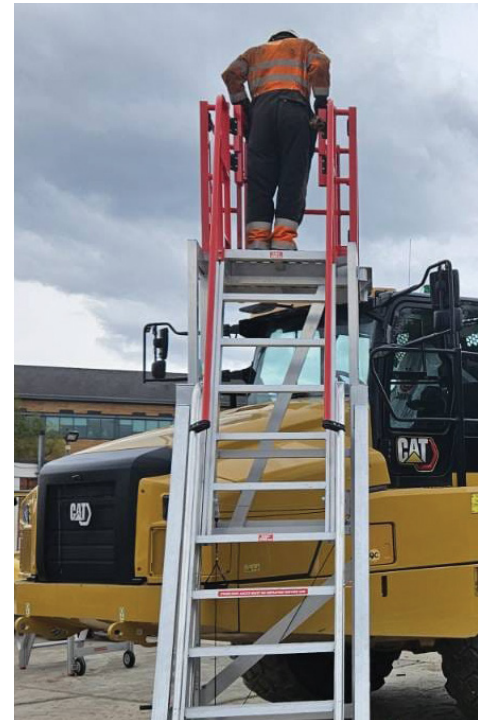

210375
7 Step UltraRaise

210376
10 Step UltraRaise

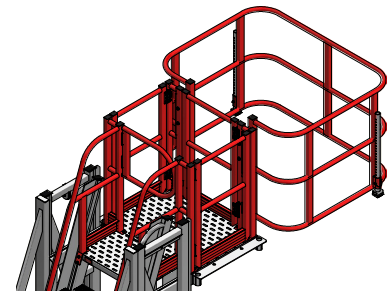

210378
Small Loop Guardrail Frame

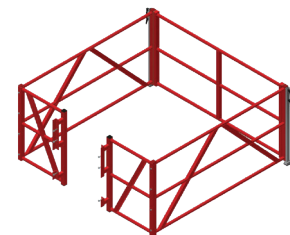

210377
Large Loop Guardrail Frame

01 Standard Products

UltraRaise Platform - Accessories & Gallery

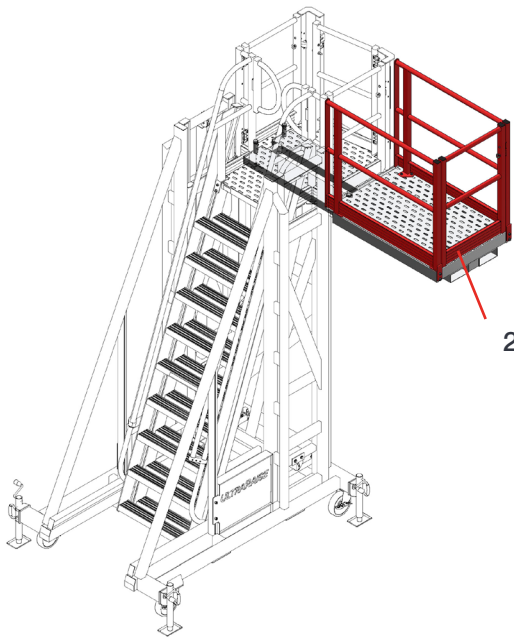

210416 UltraRaise Side Cantilever Stand

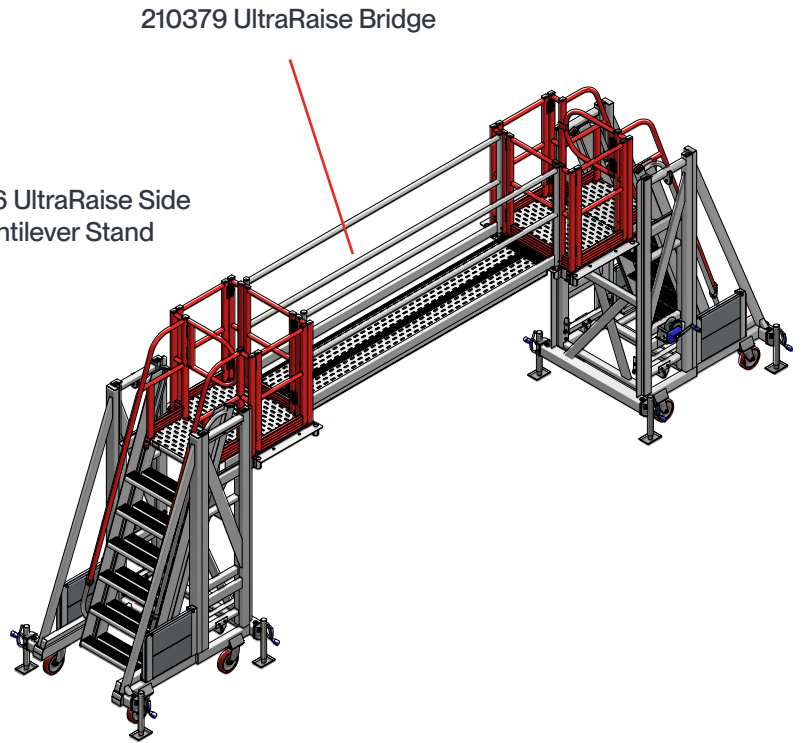

210379 UltraRaise Bridge

In-Situ Gallery



01 Standard Products

BridgeDeck

Code	Description	Max Height
210465	BridgeDeck 6 Step Base Platform (LH Access)	1700mm
210466	BridgeDeck 6 Step Base Platform (RH Access)	1700mm
210467	BridgeDeck 9 Step Base Platform (LH Access)	2540mm
210468	BridgeDeck 9 Step Base Platform (RH Access)	2540mm
210469	BridgeDeck - Adjustment Pack (to suit 6/9 step) - 900mm	2600mm (6 Step), 3440mm (9 Step)
210470	BridgeDeck - Adjustment Pack (to suit 9 step) - 1200mm	3440mm
210471	BridgeDeck Bridge 2.5mL Bridge	-
210472	BridgeDeck Bridge 3.0mL Bridge	-
210473	BridgeDeck Bridge 4.2mL Bridge	-

- Perfect for bridging access over plant and equipment.
- Can be used without bridge as maintenance platforms, or with bridge as a complete system.
- Height adjustment packs are used to configure to differing bridge heights.
- Easily height adjustable using hand winch.
- Can bridge off the side or end of base units.
- Pneumatic wheels are available for rough terrain.

Complies with
Canadian OH&S

Custom Configurations &
Sizes also Available

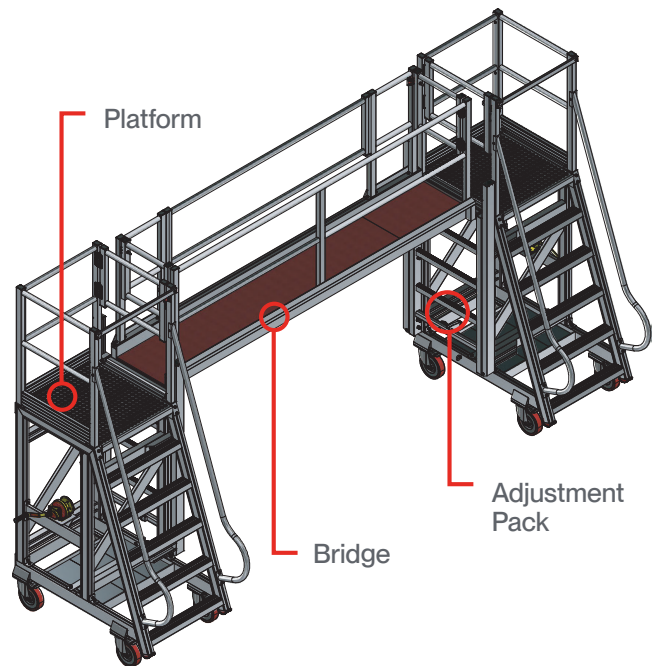

01 Standard Products

BridgeDeck



Customize your BridgeDeck



Adjustable
Height
Bridge



Step 1: Choose Your Platform



BridgeDeck 6 Step
Base Platform

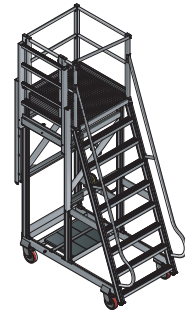

BridgeDeck 9 Step
Base Platform

Step 2: Choose your Height Adjustment Pack

900mm height adjustment packs can be used on both the 6 and 9 step BridgeDeck platforms, 1200mm packs can be used with the 9 step platforms only.

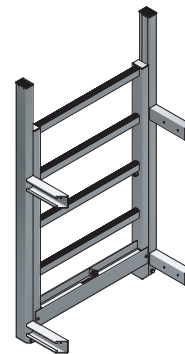

Step 3: Choose Your Bridge Length

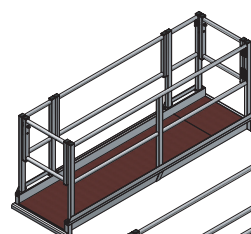

2.5m x 0.71m Bridge

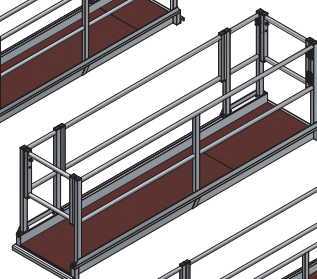

3.0m x 0.71m Bridge

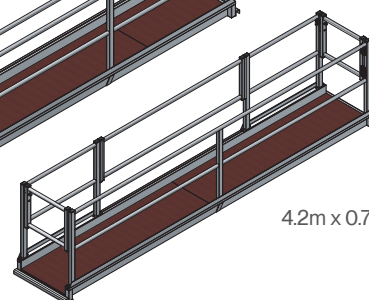

4.2m x 0.71m Bridge



01 Standard Products

Adjustable Chassis Rail Edge Protection

Code	Description
210881	Haul Truck Chassis Guardrail Frame – Telescopic. Adjusts in length from 900mmL – 1500mmL*
210880	Haul Truck Chassis Guardrail Frame – Telescopic. Adjusts in length from 1400mmL – 2400mmL*
210883	Haul Truck Chassis Guardrail Frame – Telescopic. Adjusts in length from 2000mmL – 3000mmL*
210882	Haul Truck Chassis Guardrail Frame – Telescopic. Adjusts in length from 2400mmL – 3400mmL*
210885	Haul Truck Chassis Guardrail Frame – Telescopic. Adjusts in length from 900mmL – 1500mmL**
210884	Haul Truck Chassis Guardrail Frame – Telescopic. Adjusts in length from 1400mmL – 2400mmL**
210887	Haul Truck Chassis Guardrail Frame – Telescopic. Adjusts in length from 2000mmL – 3000mmL**
210886	Haul Truck Chassis Guardrail Frame – Telescopic. Adjusts in length from 2400mmL – 3400mmL**

* Suits Chassis widths between 190mm - 235mm, ** Suits Chassis widths between 290mm - 326mm

- Compatible with any haul truck and can be fitted on a square or rolled chassis.
- Adjustable from 0.9mL to 3.4mL giving it the flexibility to fit any workspace.
- The clamping system provides a positive lock onto the chassis frame, rather than merely slipping over the chassis as other systems do.
- Eliminates the need for a separate chassis rail kit for each truck.
- Easily and quickly adjusted using hand tightening couplers.

Complies with
Canadian OH&S

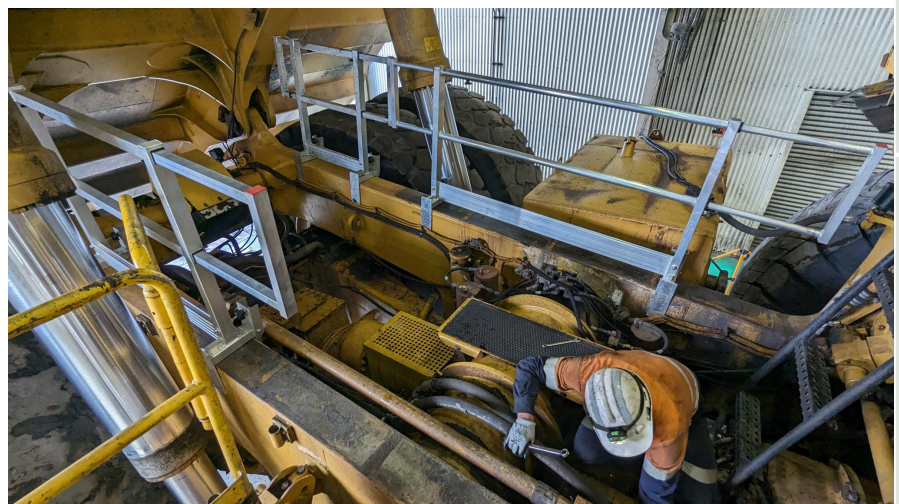



Section 02

Open Pit Solutions

Haul Truck Access

Truck Chassis Access Platform	30
Hoist Cylinder Access Platform	32
Air Filter Access Platform	33
Lower Radiator Access Platform	34
Tire Fitters Platform	35
Truck Bumper/Tray Pin Access Platform	36
Tray Pin & Line Boring Access Platform	37
Engine Bay Access Platform	38
Tray Access Platform	39

Dozer Access

Extended Cantilever Engine Bay Platform	43
D10/D11 Dozer End Cantilever Stand	44
D10/D11 Side Cantilever Stand	45
D10/D11 Dozer Track Mounted Guardrail	46

Grader Access

Grader Access Platform	49
------------------------	----

Loader Access

Tilt Cylinder Access	48
Boom Hose Access Platform	50
Strut Access Platform	51
Bucket Access Platform	52
Industry Story - Bowen Basin Workshop	53

A Better Way

Haul Truck Access



Extended Reach Access Platform

Tire Fitters Platform

Chassis Access Platform

Stair Access SMP

02 Open Pit

Truck Chassis Access Platform

- Cantilever Access Platform provides safe access to the truck chassis, over the hydraulic box and fuel tank
- 45° stair access allows easy movement of tools and equipment into the chassis area.
- Optional wind-down jacks for added stability and levelling.
- Available with Batwing Gates for improved safety and usability.
- Optional bolt-on storage decks for chassis guardrails.

225kg
WLL

Complies with
Canadian OH&S

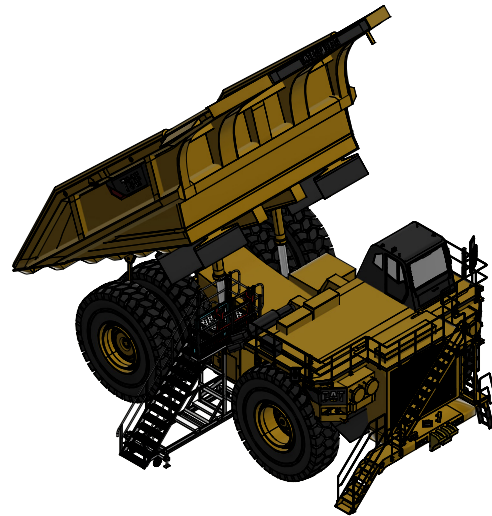

Chassis Access Platforms available
for all CAT, Liebherr, Hitachi, Komatsu
and other trucks.

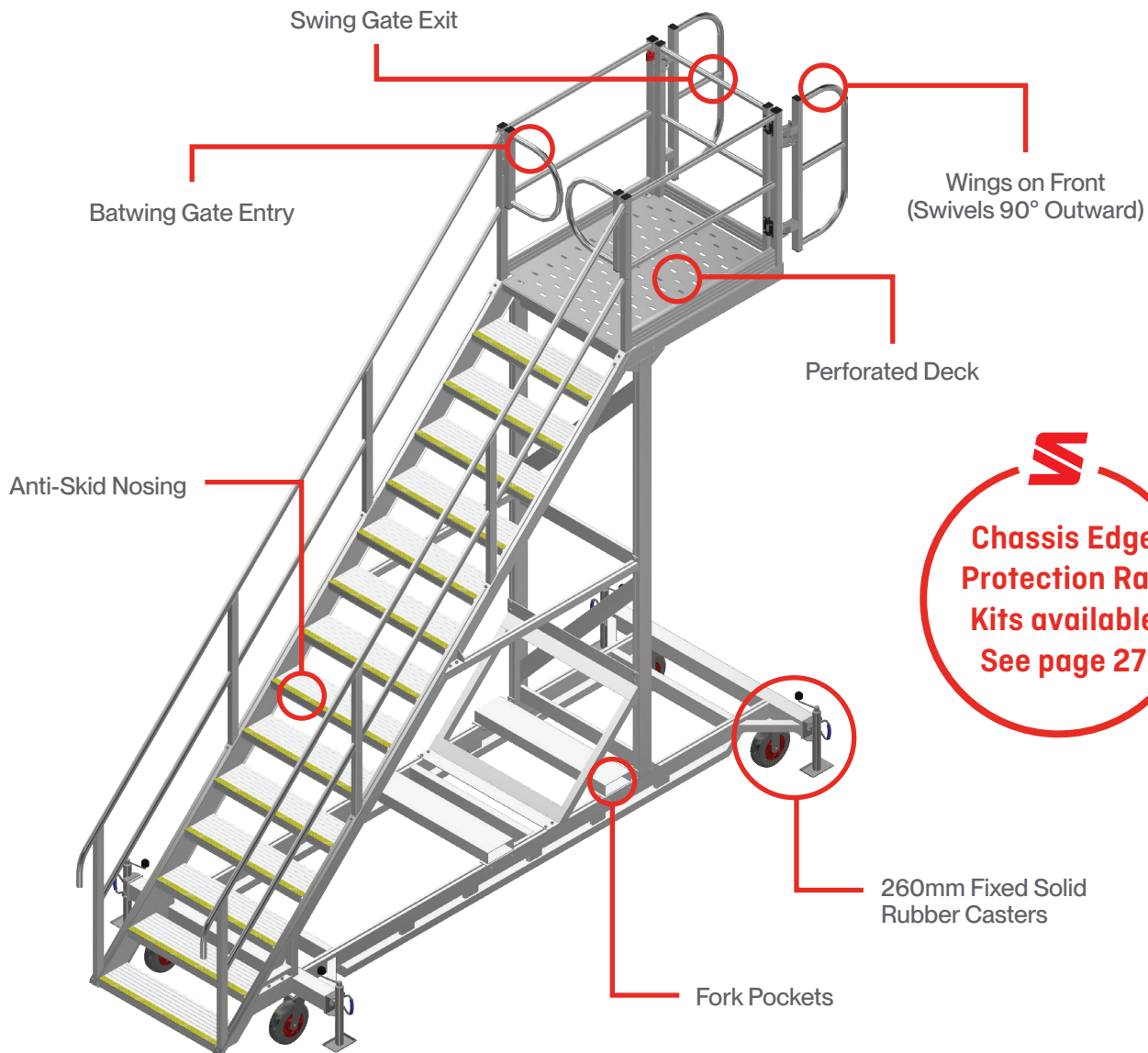

Haul Truck Access

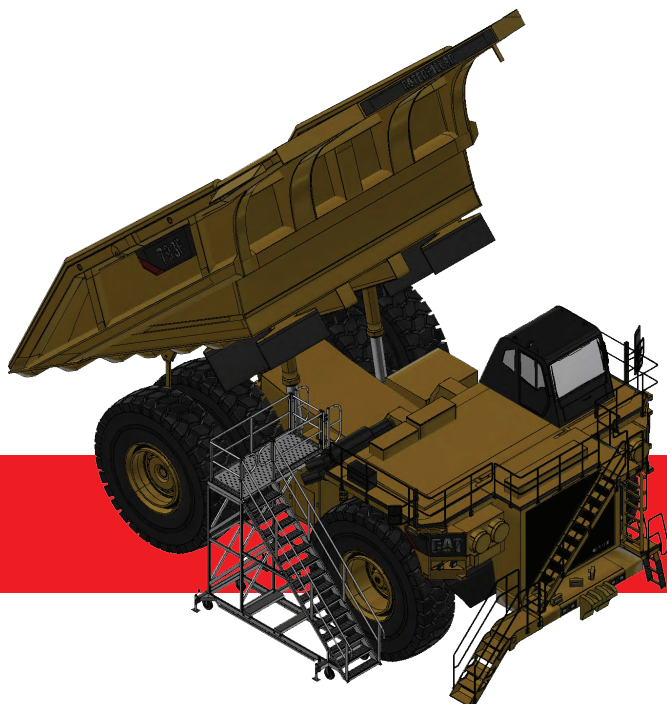

Side Cantilever Design
For Tighter Bays

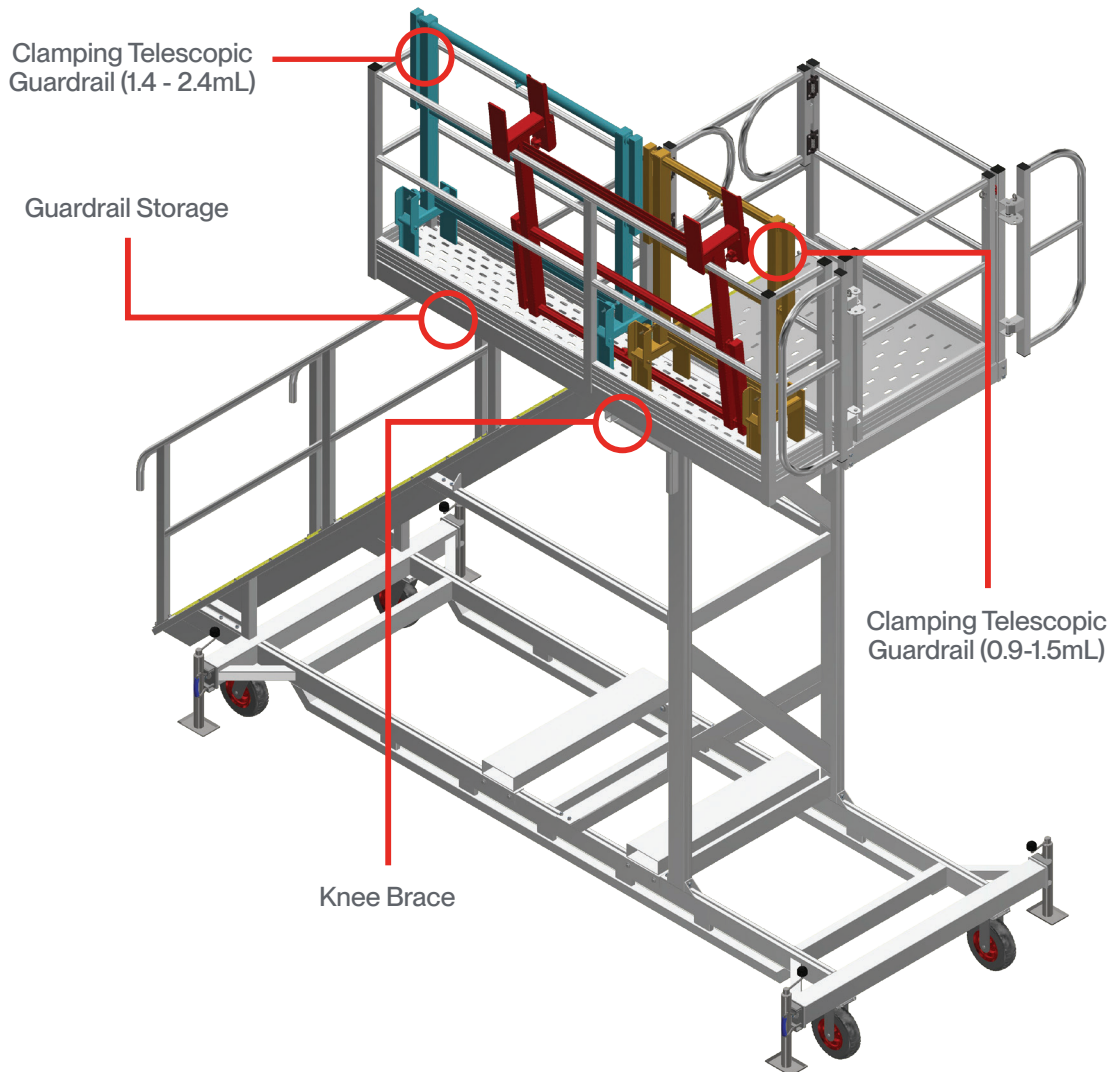

02 Open Pit

Hoist Cylinder Access Platform

- Dimensions: 1.4mL x 0.5mW x 2.3mH (length includes 1.0mL clear cantilever).
- Provides access between hydraulic box/fuel tank and tire for servicing hoist cylinders.
- 45° stairway access with griptread extrusion steps and anti-skid nosings.
- Handrail and midrail on both sides, with swing gate at entry point.
- 1.0m clear cantilever for full reach into the work area.
- Heavy-duty 200mm casters for mobility.
- Counterweights included for added stability.
- Fork channels for easy relocation.

225kg
WLL

Complies with
Canadian OH&S

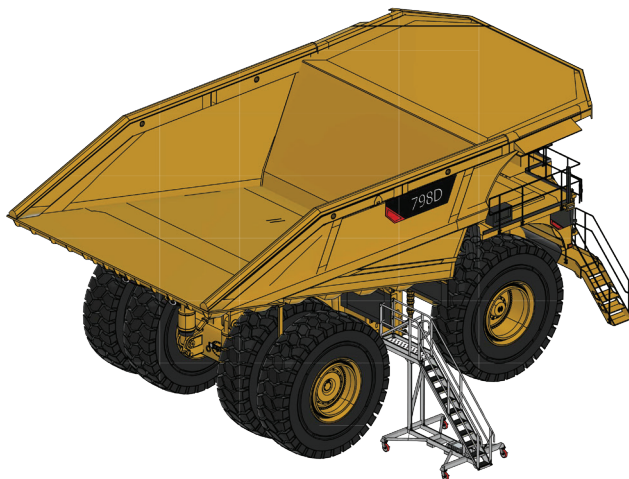

11-Step Hoist Cylinder Access Platform

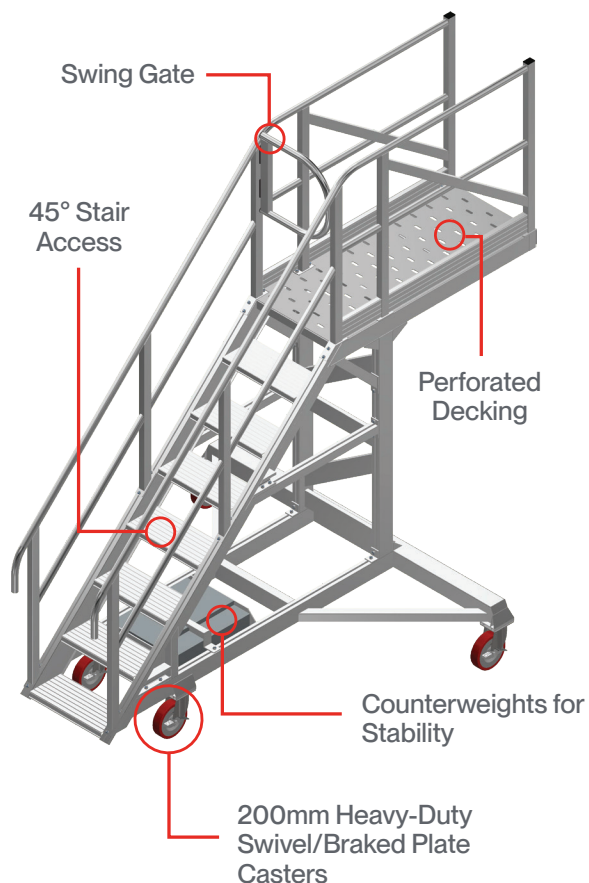

02 Open Pit

Air Filter Access Platform

- Dimensions: 1.4mL x 1.4mW x 1.7mH.
- Length includes 0.7m supported cantilever to the RHS.
- Guardrail, midrail, and toeboard frames on all sides except leading edge
- 0.6m wide parallel stairway/landing access at 45° slope.
- Griptread extrusion steps with anti-skid nosings for safe footing.
- Handrail and midrail on both sides with swing gate at entry point.

225kg
WLL

Complies with
Canadian OH&S



Removable Side Panels



70° Stair Access with Rails
and Anti-slip Nosings

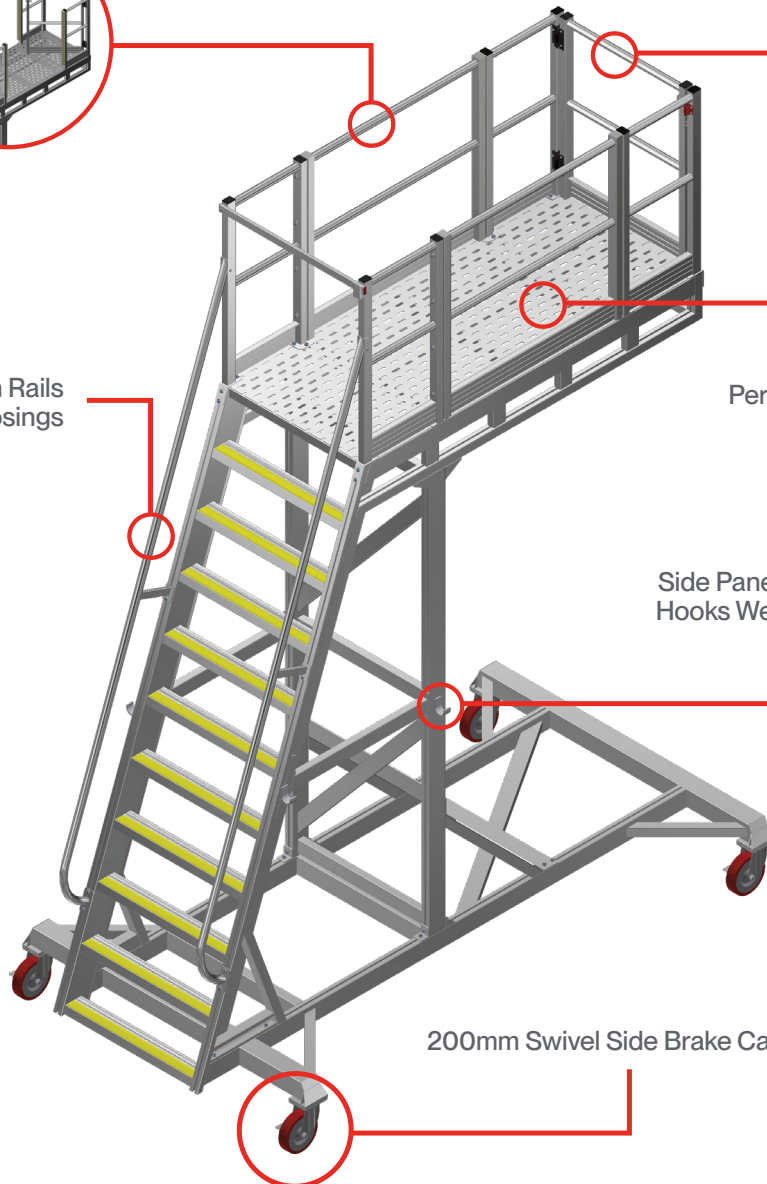

Self-closing
Hinged Gate

Perforated Decking

Side Panels Stowed on the
Hooks Welded to the frame

200mm Swivel Side Brake Casters

02 Open Pit

Lower Radiator Access Platform

- Provides safe radiator access for CAT, Liebherr, Hitachi, and Komatsu trucks.
- 45° stair access to the platform.
- Self-closing gate for safe platform entry.
- Fork pockets for easy relocation.
- Heavy-duty casters and wind-down jacks for stability.

225kg
WLL

Complies with
Canadian OH&S

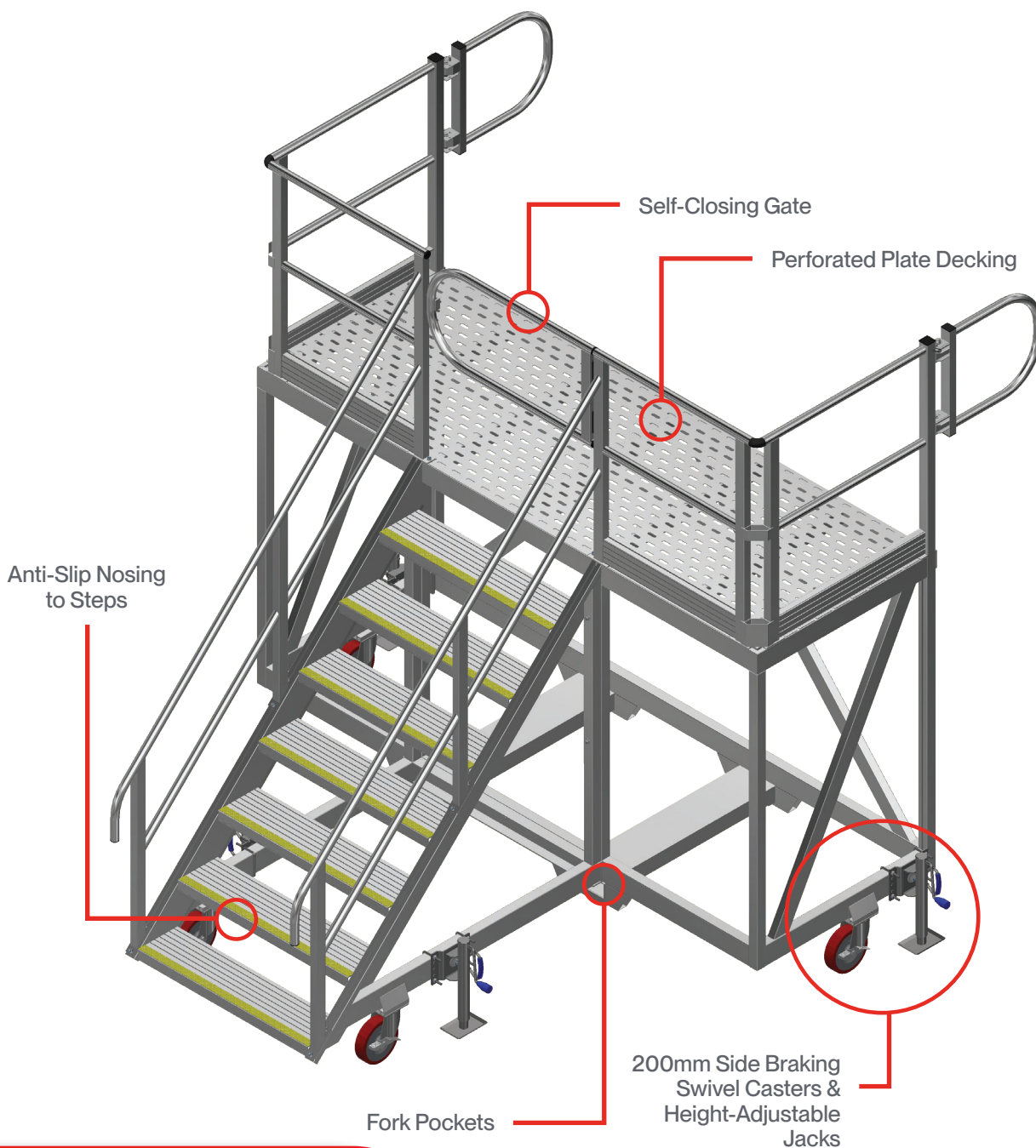

02 Open Pit

Tire Fitters Platform

- Designed to provide safe access for 1–2 users when working on, or changing tires.
- Stair access at both ends allow entry from either side of the work bay.
- Perforated platform surface enables drainage of grease and oil, maintaining a safer work area.
- Equipped with large solid rubber wheels for easy mobility on gravel or uneven surfaces.
- Fitted with a lever brake for quick and secure setup prior to use.

225kg
WLL

Complies with
Canadian OH&S

Pneumatic Drill
Gantry also
Available

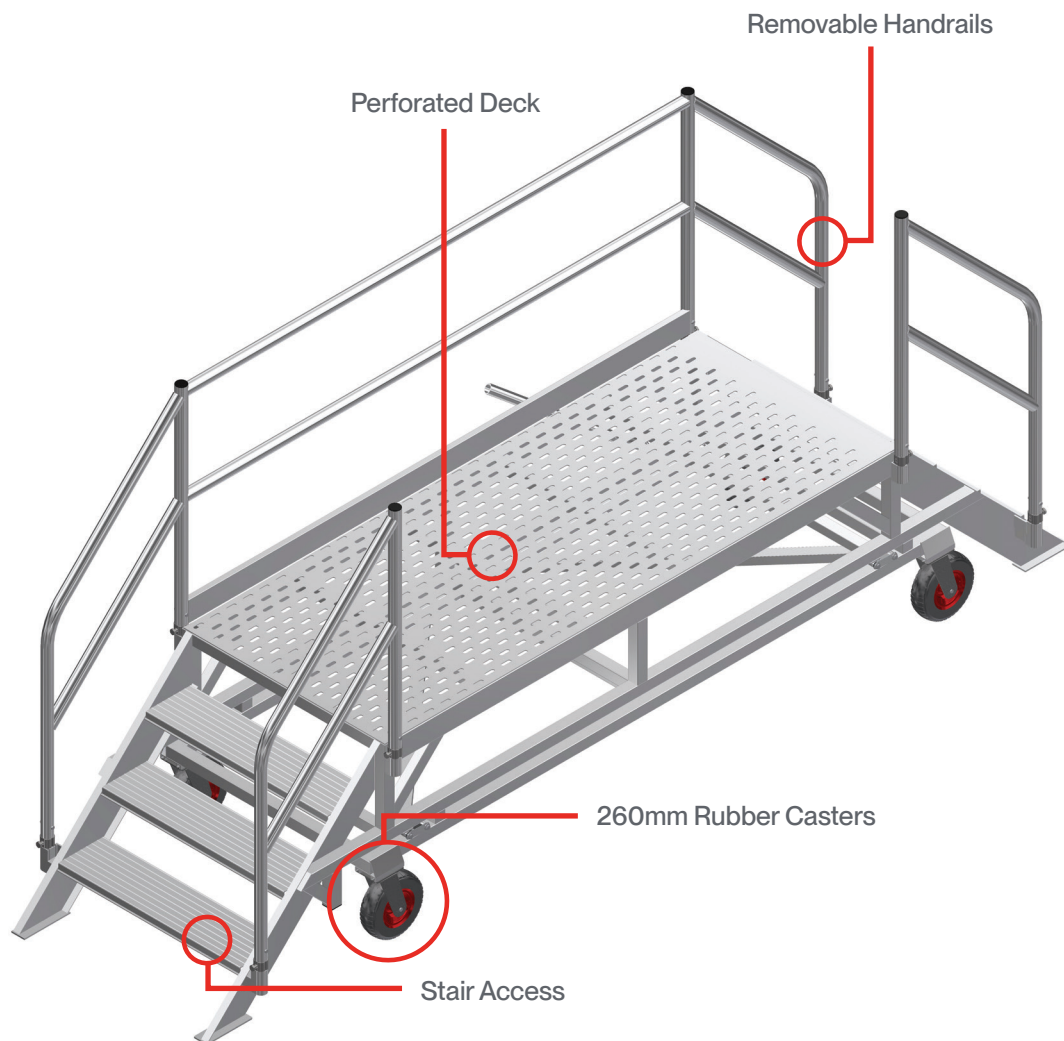

02 Open Pit

Truck Bumper/Tray Pin Access Platform

- Provides quick and convenient mobile stair access to the truck bumper.
- Ideal for in-service inspections and maintenance.
- 45° stair angle designed to allow safe carrying of tools and equipment onto the truck.
- Enables easy access to tray pins, radar screens, and other service points.
- Available in a range of sizes to suit all truck types.

225kg
WLL

Complies with
Canadian OH&S

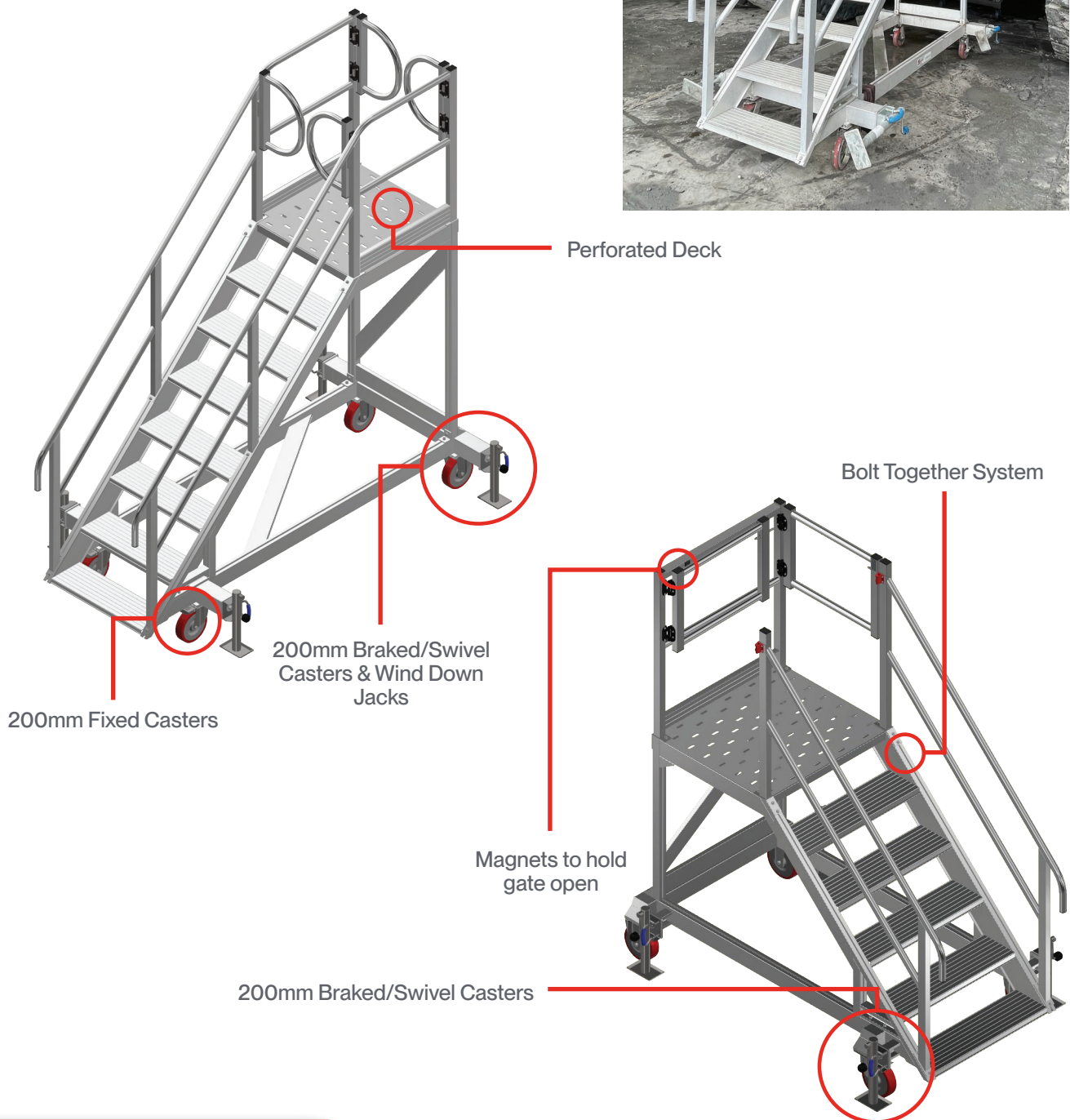

02 Open Pit

Tray Pin & Line Boring Access Platform

- Platform dimensions: 1.2mL x 2.45mW x 1.35mH.
- Stairway access with 45° slope with griptread extrusion steps and anti-skid nosings for enhanced safety.
- Handrail and midrail on both sides for secure access.
- Guardrail, midrail, and toeboard frames on all sides for comprehensive fall protection.
- Leading edge features three removable sections, each 0.8mW, for flexible access.

225kg
WLL

Complies with
Canadian OH&S

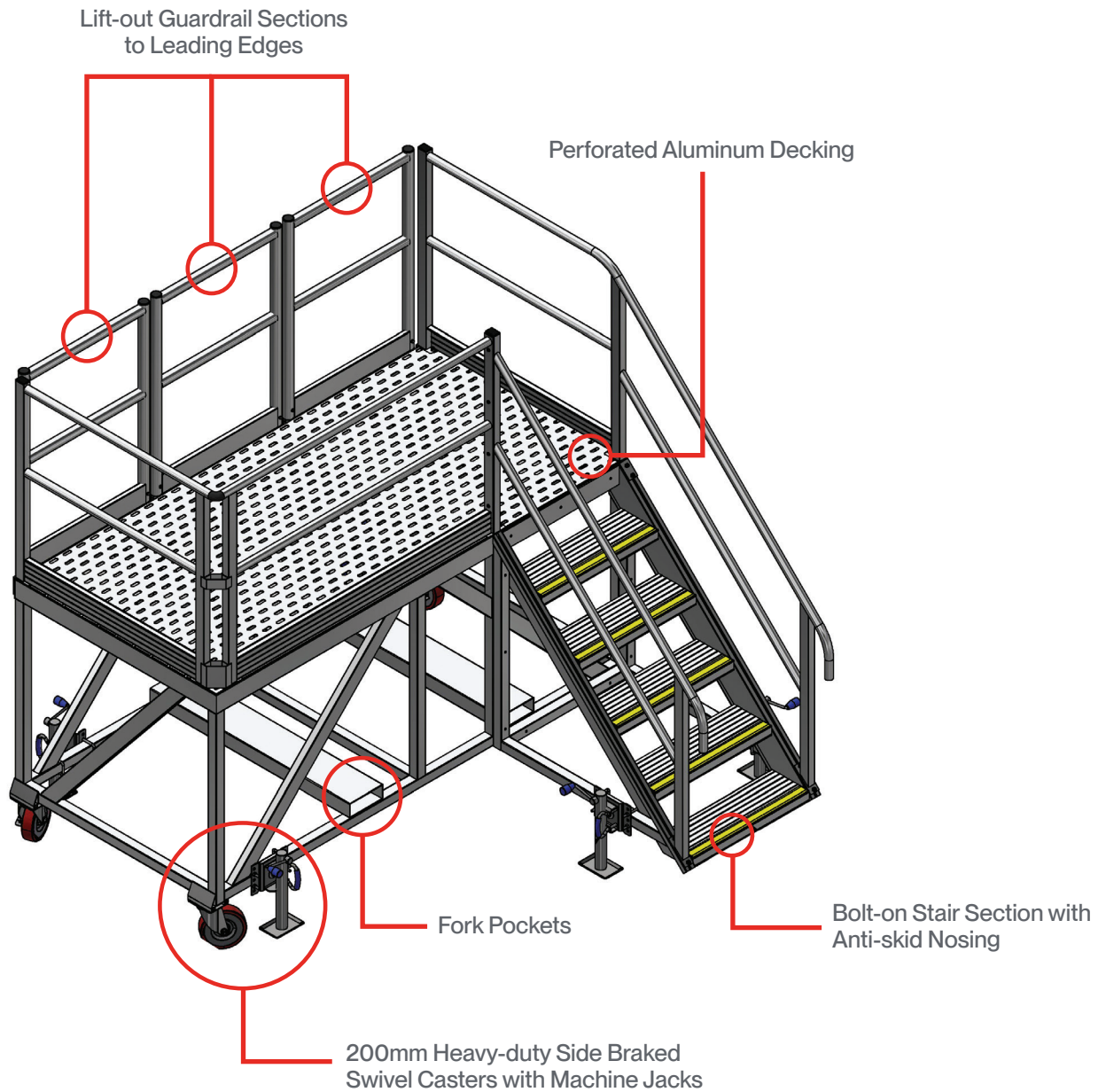
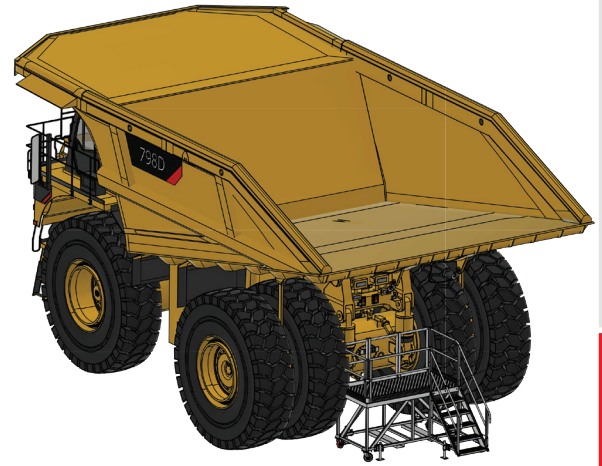

02 Open Pit

Engine Bay Access Platform

- Platform dimensions: 1.0mL x 0.55mW x 2.0mH
- Stairway access at a 45° slope, with griptread extrusion steps and anti-skid nosings.
- Handrail and midrail on each side, with a swing gate at the point of entry.
- Guardrail, midrail, and toeboard frames on each side, with an open leading edge.
- Perforated and swaged decking material.

225kg
WLL

Complies with
Canadian OH&S

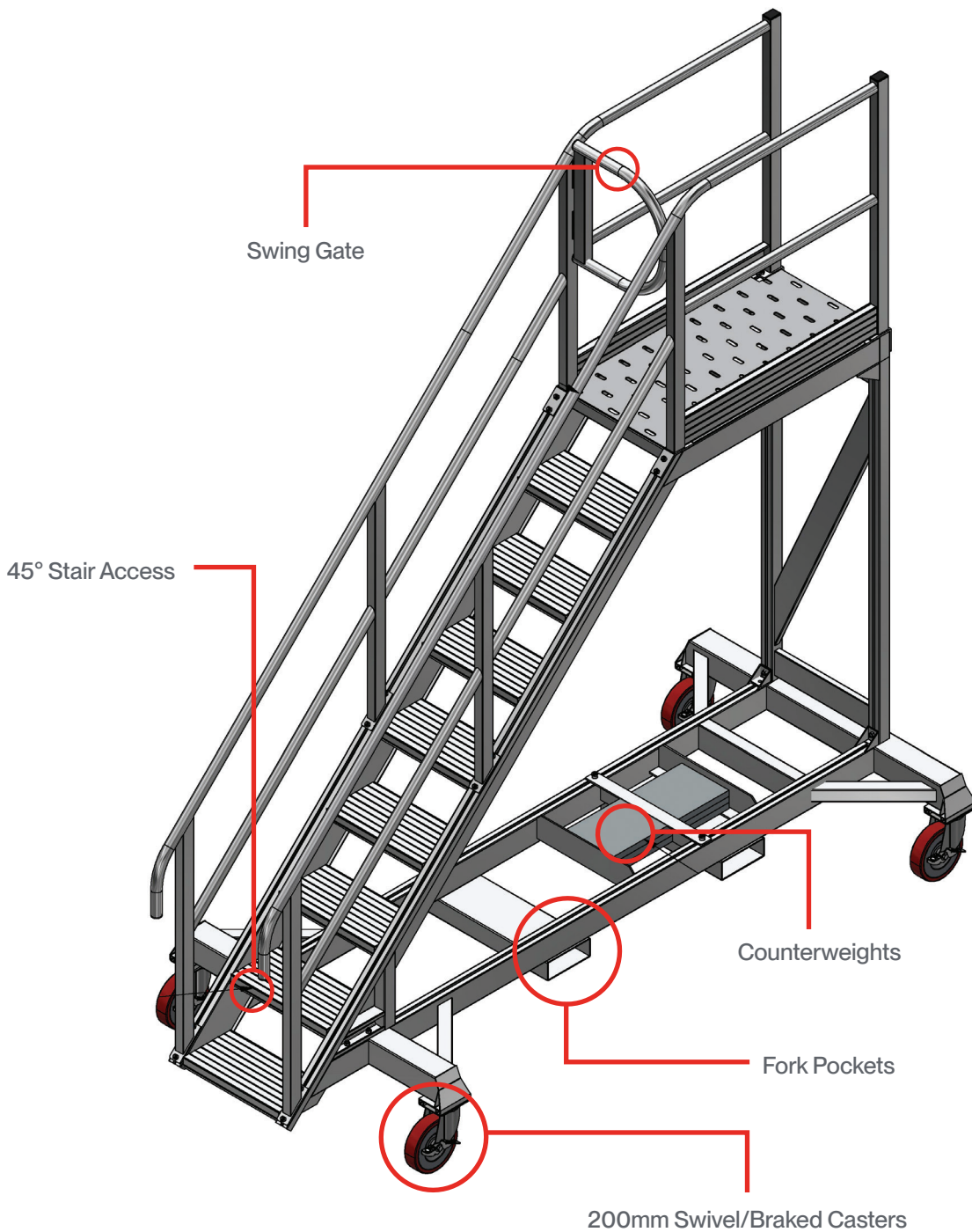

02 Open Pit

Tray Access Platform

- Platform dimensions: 2.145mL x 2.0mW x 5.0mH (minimum), 6.0mH (maximum).
- Length includes a 1.4mL clear cantilever.
- Height adjustment via winch, cable, and pulley system with spring pins that auto-release as the platform is raised and auto-lock as it is lowered.
- Fixed stairway access to 2.6mH mid-landing & self-levelling stairway access to height adjustable section, maximum 45° slope, with griptread extrusion steps with anti-skid nosings.
- Guardrail, midrail, and toeboard frames to all sides of the platform and mid-landing, except the leading edge.
- Hinging wings on either side of the platform provide edge protection to the rear of the tray (8.4m overall width).
- Wings fold back along each side of the platform when not in use.

500kg
WLL

Complies with
Canadian OH&S



02 Open Pit

Tray Access Platform - A Closer Look

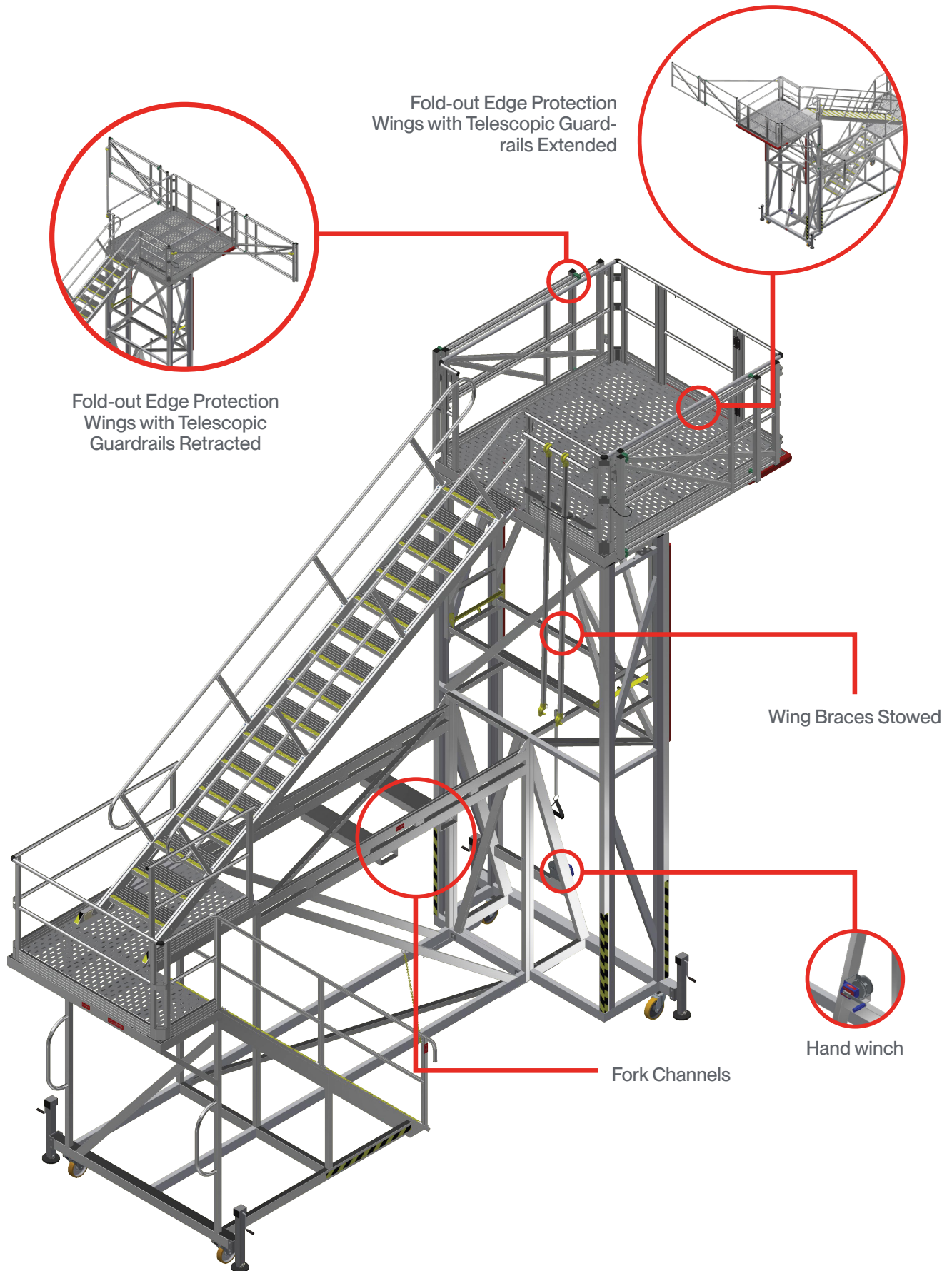

02 Open Pit

Custom Haul Truck Access Solutions

Stocked Solutions

Open Pit Solutions

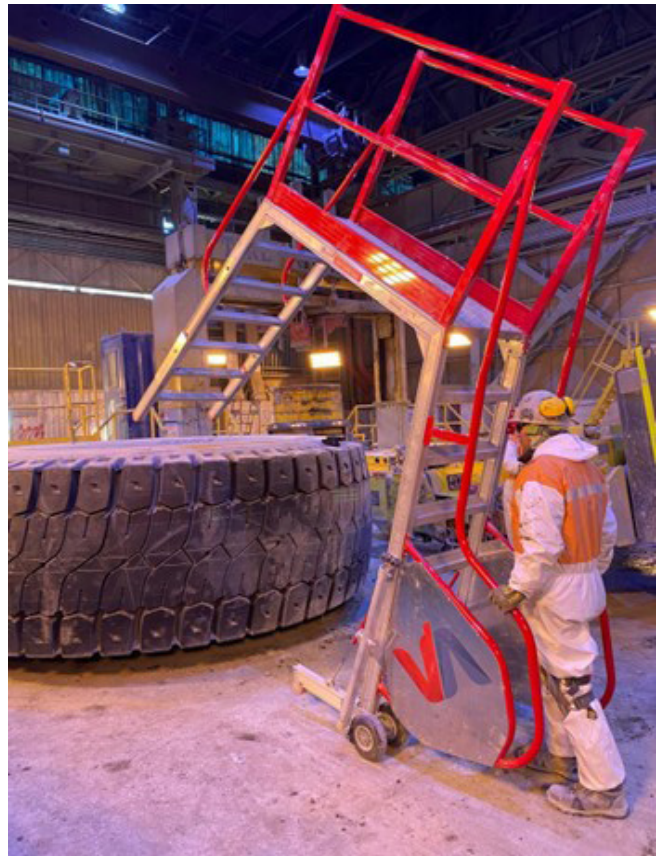

Underground Solutions

Plant Maintenance

Dozer Access

Extended Reach Cantilever Platform

BridgeDeck

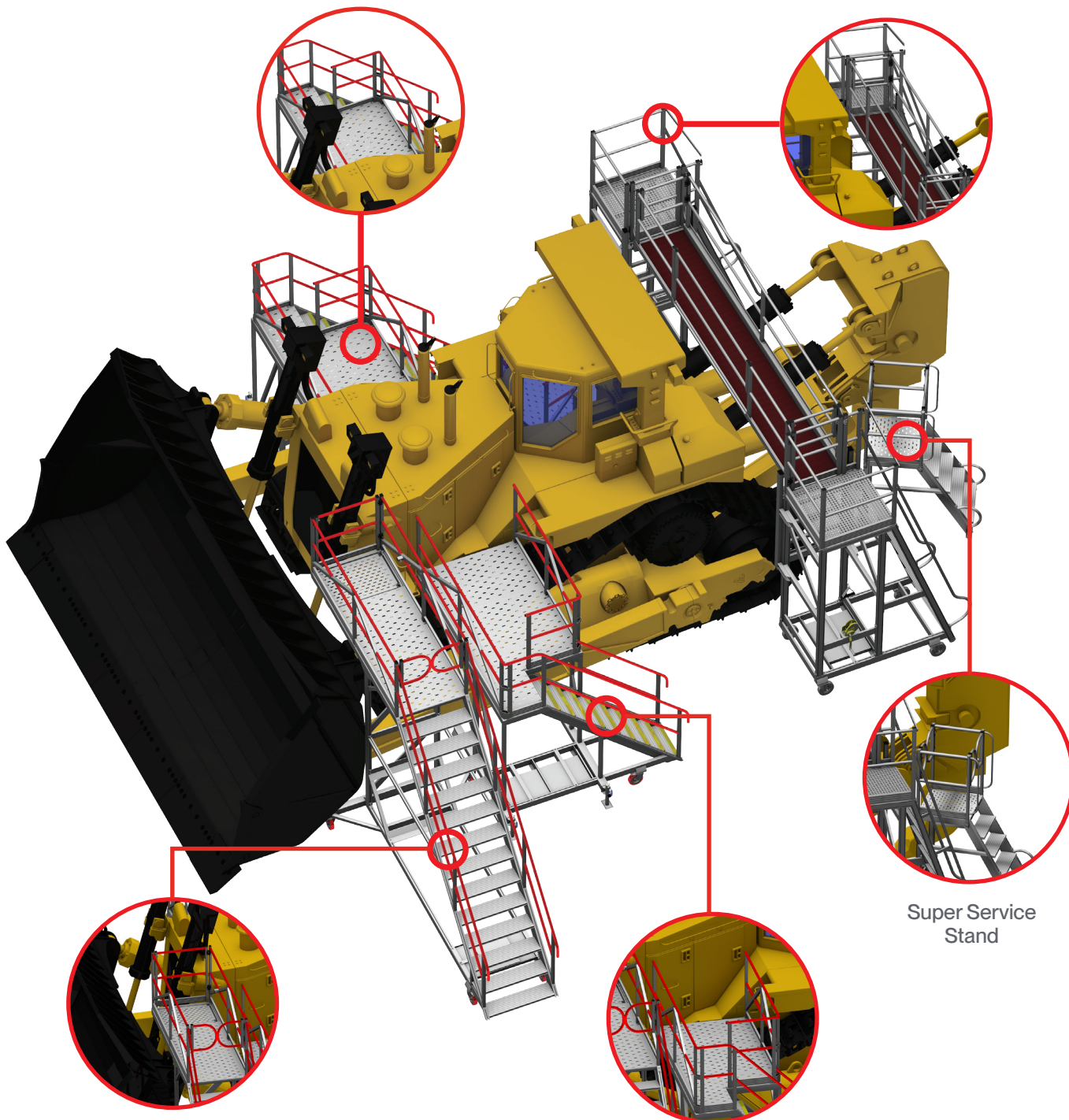

Extended Reach Dozer Access Platform

Extended Reach Cantilever Platform

Super Service Stand

02 Open Pit

Extended Side Cantilever Stand

- Heavy-duty construction ideal for mining workshops.
- Fully engineered with counterweights.
- Manufactured as a LH or RH unit.
- Adjustable jacks for on-site stability.
- Allows access over the push arm and tracks right up to the engine bay door.

225kg
WLL

Complies with
Canadian OH&S

Suits CAT D11 &
Komatsu D475

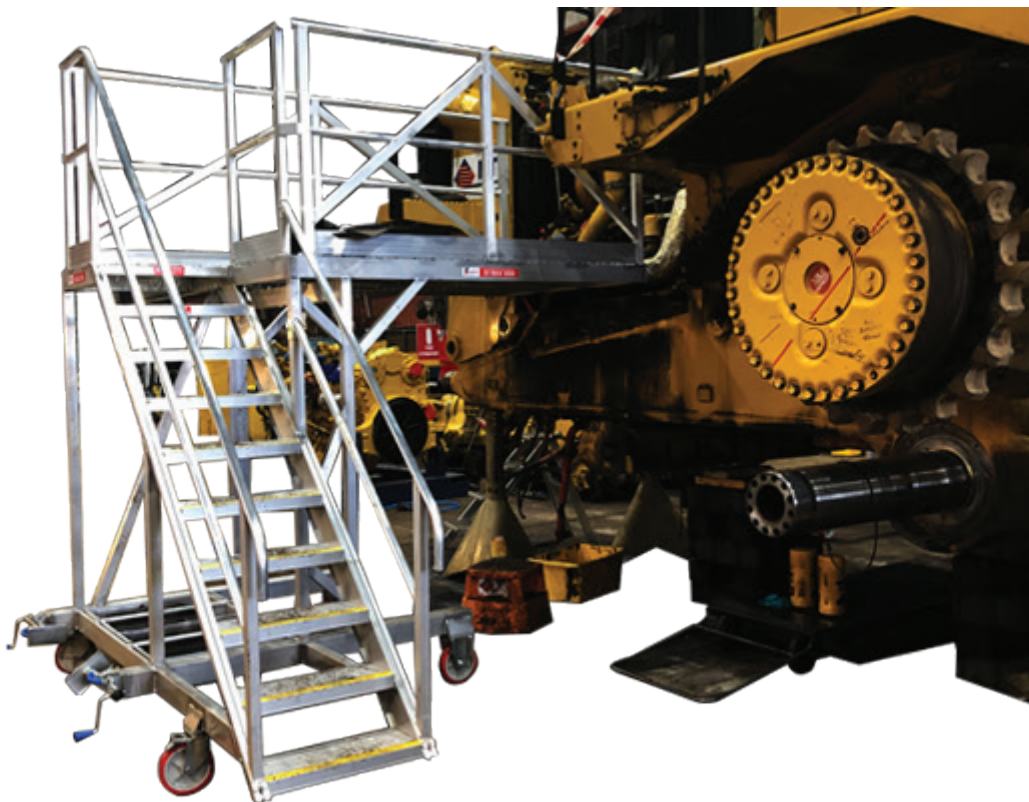

02 Open Pit

D10/D11 Dozer End Cantilever Stand

- High-tensile box-section aluminum frame - built for tough mining environments.
- Cantilevered platform designed for servicing the engine bay.
- Custom made to suit all machine makes and models.
- 45° stair access allows users to safely carry tools onto the platform.
- Fold-out edge protection provides full fall restraint.

300kg
WLL

Complies with
Canadian OH&S



Self-closing Batwing Gates

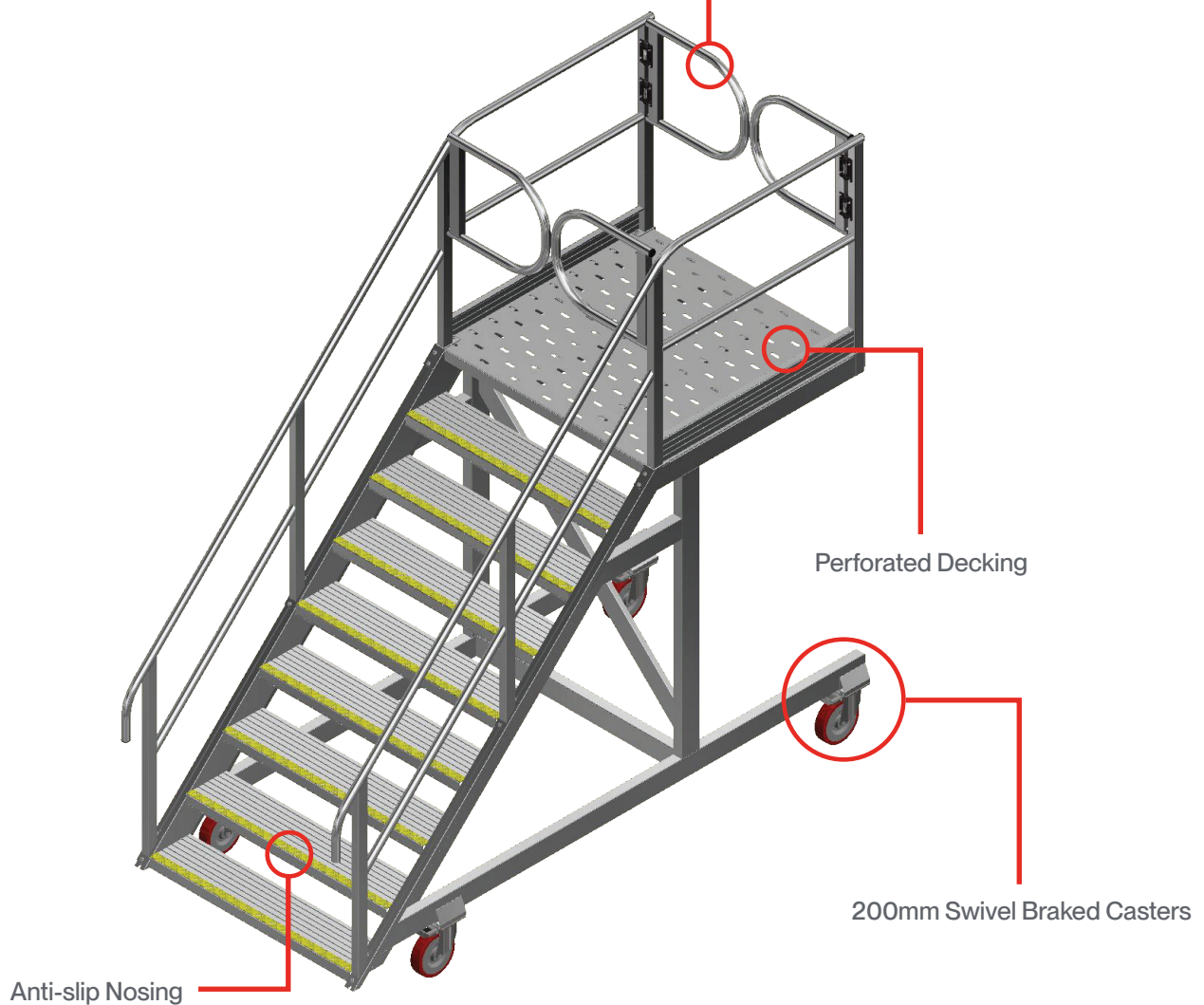

Perforated Decking

200mm Swivel Braked Casters

Anti-slip Nosing



02 Open Pit

D10/D11 Side Cantilever Stand

- Provides access over the push arm to the track.
- LH and RH combinations available.
- Access stair positioned at 90° to the platform for a more compact design.
- Fold-out edge protection wings available as an option.
- Fork pockets also available for easy handling.
- Platform also available positioned adjacent to the stairs.

225kg
WLL

Complies with
Canadian OH&S

Suits CAT &
Komatsu Dozers



Optional Extra -
Swing Gate Entry

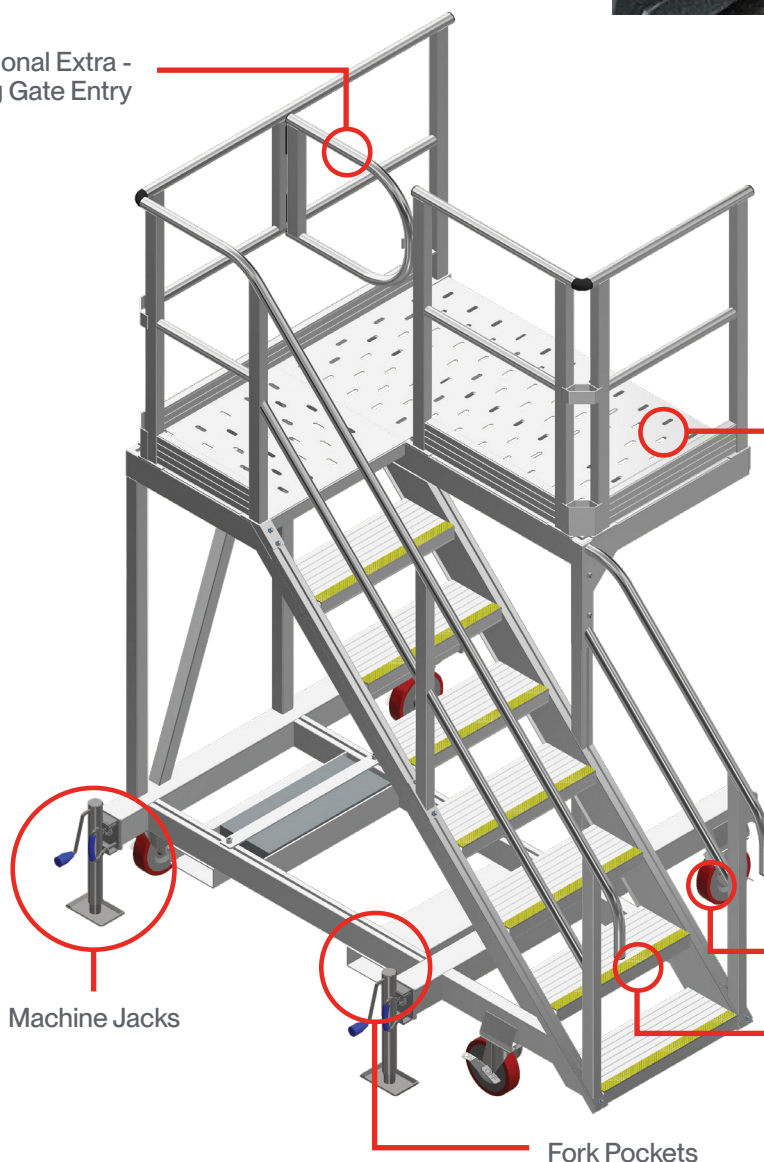

Perforated Decking

200mm Fixed Direction
Side Braking Casters

Anti-slip Nosing

Machine Jacks

Fork Pockets

02 Open Pit

D10/D11 Dozer Track Mounted Guardrail

- Lightweight handrails easily break down into smaller components for convenient assembly in the field or workshop.
- Guardrail frames clamp to the sides of the dozer track using simple hand-winding clamps.
- Each frame is split into two separate 1.0 m L sections that interlock, creating a 2.0mL × 1.0mH frame with 0.5m folding wings at the ends to close off access.
- Integrates with dozer track mats to provide a complete access and edge protection solution.

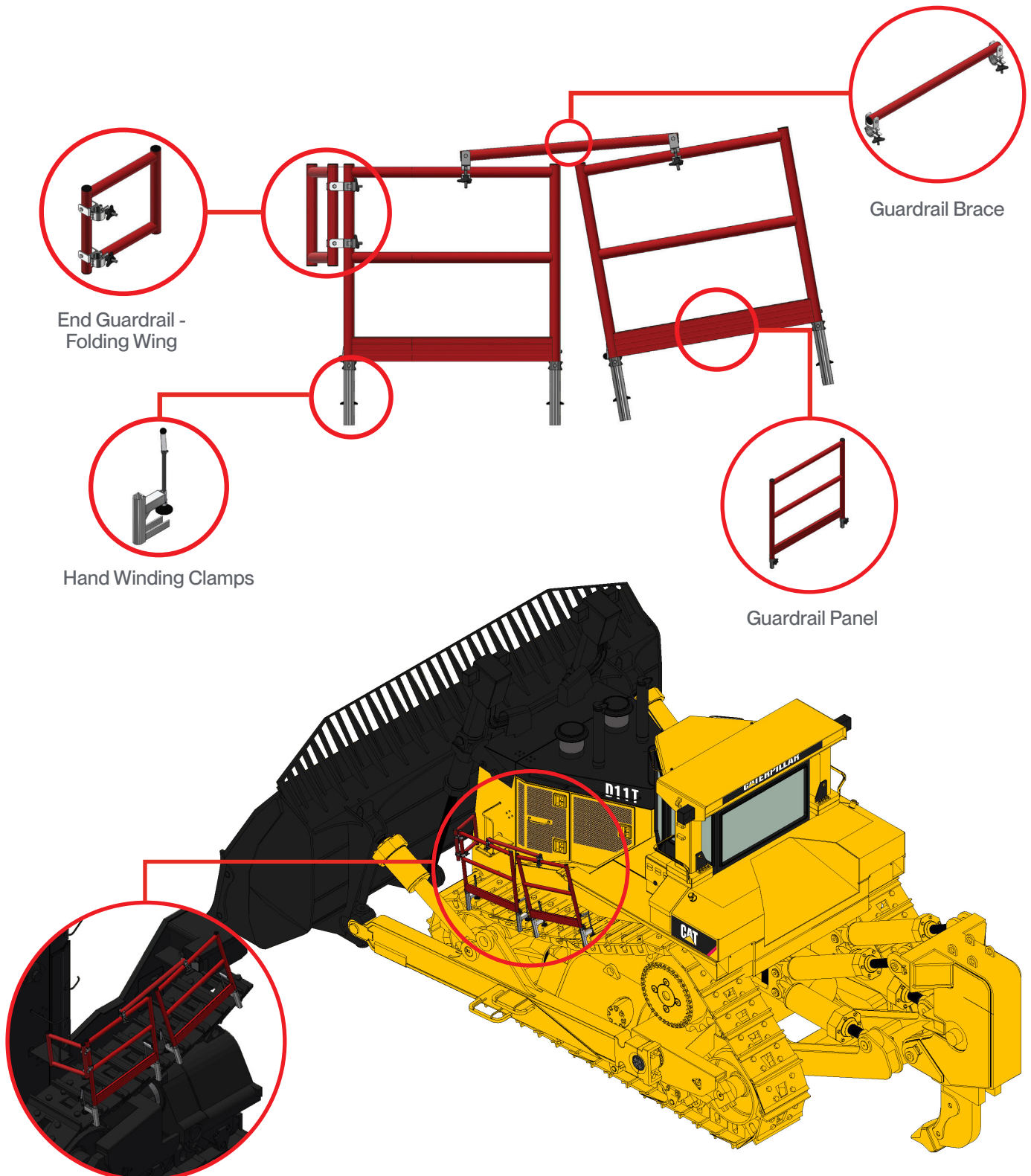

02 Open Pit

Dozer Access - Custom Height Adjustable Solutions



Stocked Solutions

Open Pit Solutions

Underground Solutions

Plant Maintenance

02 Open Pit

Tilt Cylinder Access

- Platform dimensions: 2.4mL x 1.0mW x 3.1mH (length includes a 1.5mL clear cantilever).
- Guardrail, midrail, and toeboard frames on each side, with a swing gate at the cantilever end.
- Step-ladder access at a 70° slope, featuring 100 mm wide steps with anti-skid nosings.
- Counterweights included for enhanced stability.
- Reflective hazard tape included for increased safety visibility.

150kg
WLL

Complies with
Canadian OH&S

45° Options
Available

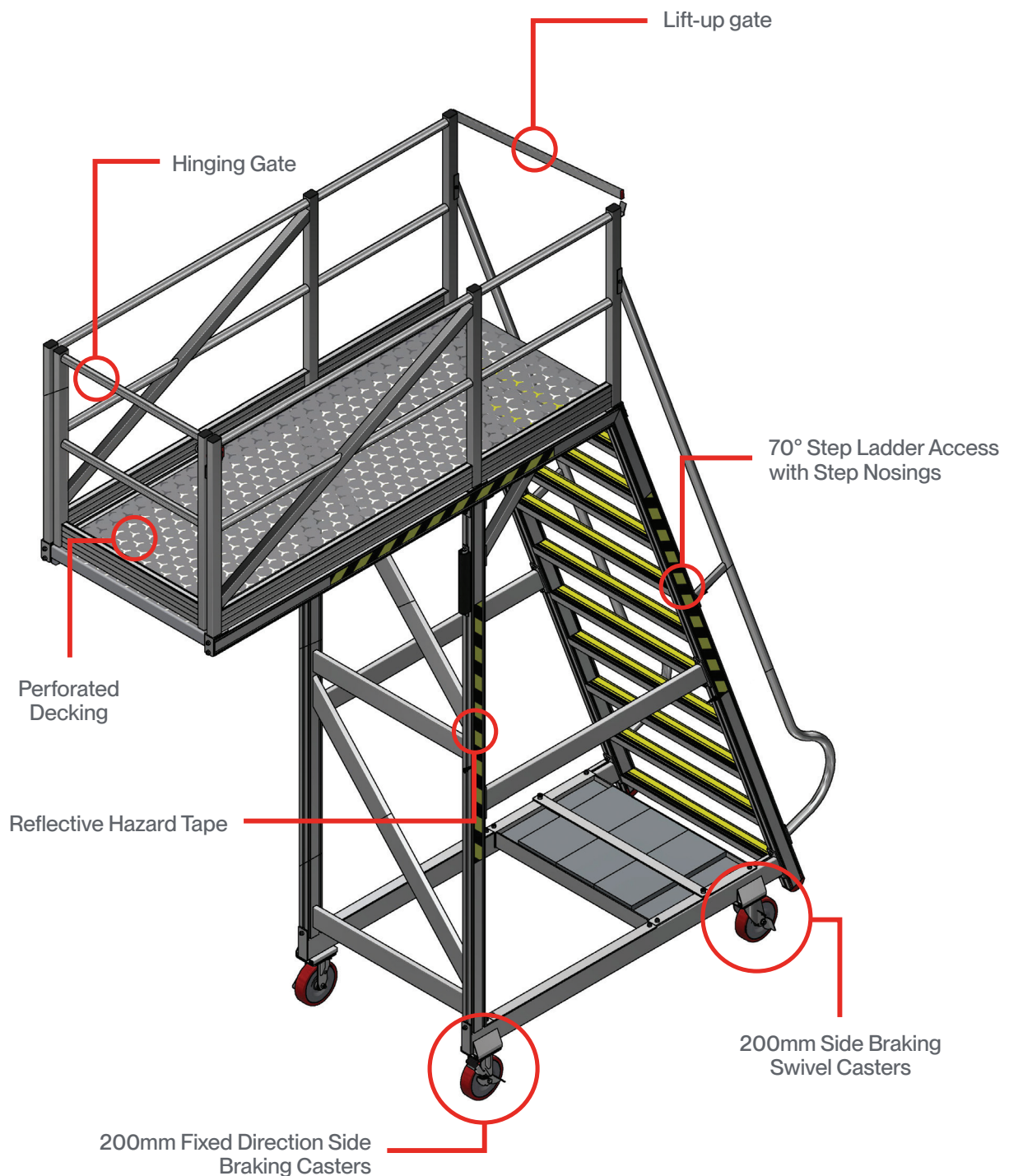

02 Open Pit

Grader Access Platform

- Provides full access over the tire directly to the engine bay doors.
- 1mL clear cantilever for unobstructed access.
- Self-closing swing gates for safe entry and exit from the platform.
- Raised, swaged, perforated decking promotes drainage and enhances safety.
- Fully customisable to fit a variety of grader types.

225kg
WLL

Complies with
Canadian OH&S

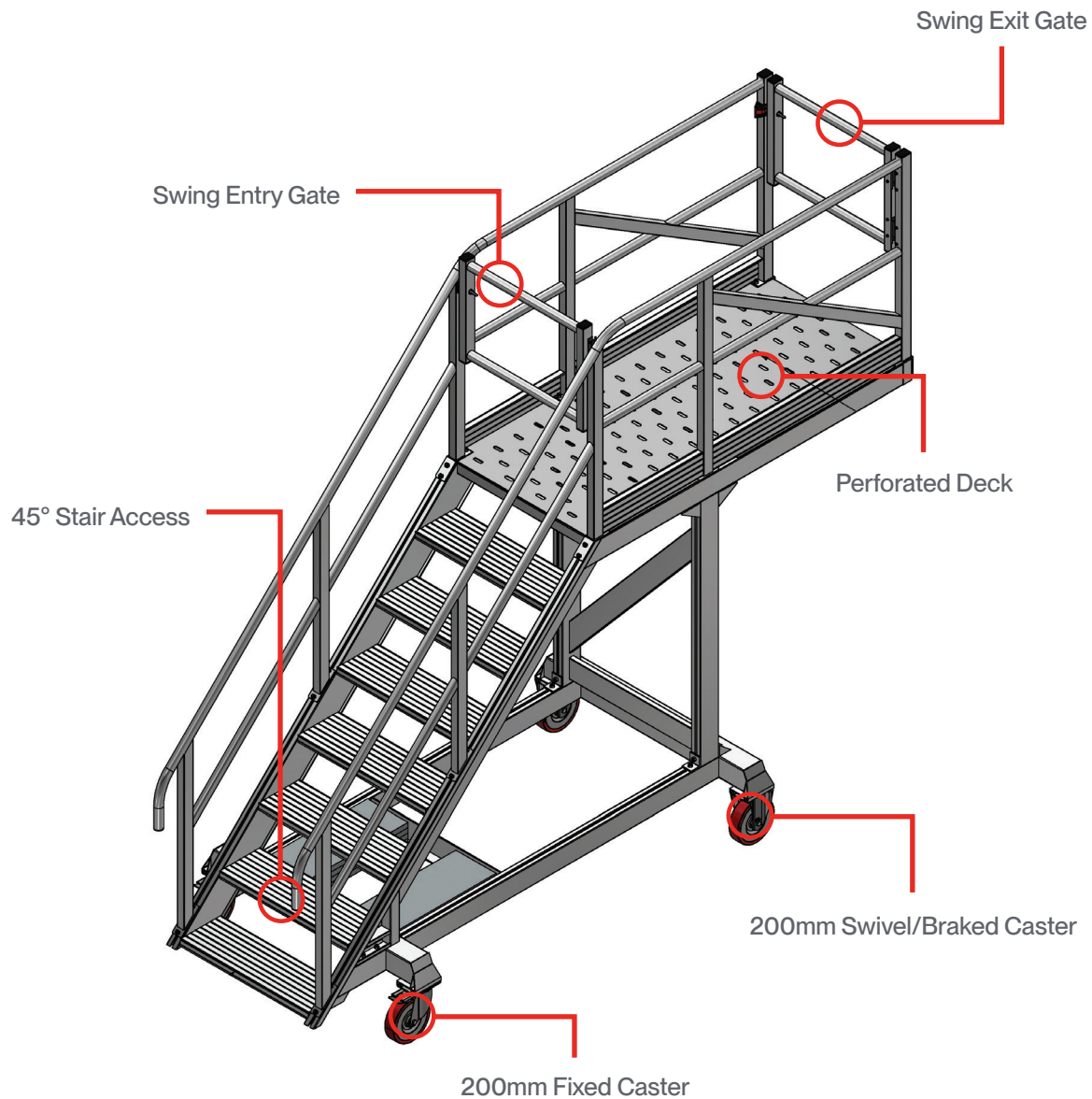

02 Open Pit

Boom Hose Access Platform

- Platform dimensions: 2.7mL x 0.95mW x 0.8mH (length includes a 0.7mL x 0.4mW curved cantilever section).
- Spigot-mounted, removable guardrail, midrail, and toeboard frames on all sides.
- Leading edge features seven 0.7 m wide removable sections, conveniently stored on hooks welded to the subframe when not in use.



500kg
WLL

Complies with
Canadian OH&S

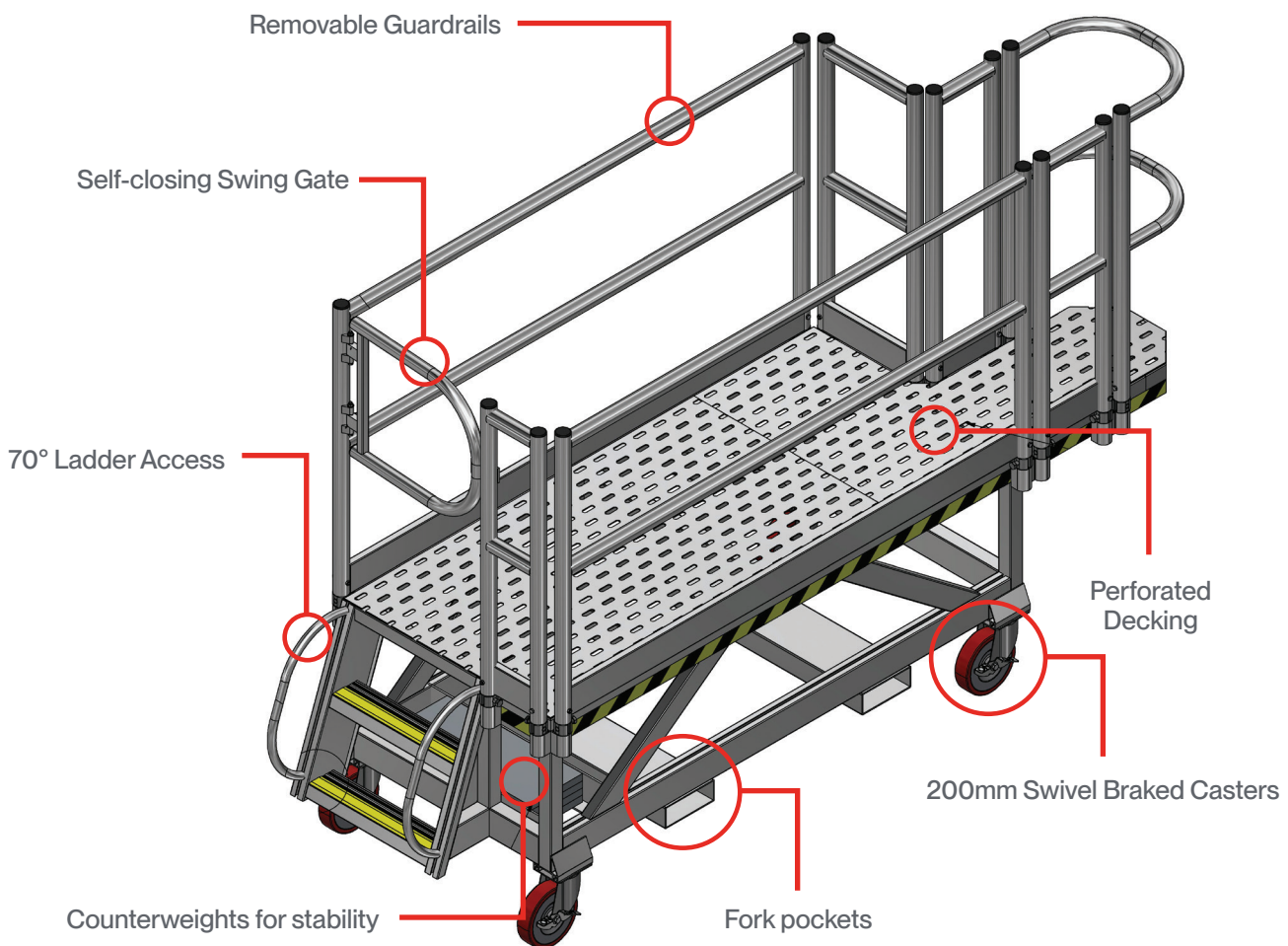

02 Open Pit Strut Access Platform

- Platform dimensions: 2.4mL x 0.95mW x 1.1mH (length includes a 0.4mW x 0.5mL supported cantilever section).
- Step-ladder access at a 70° slope, with 100 mm wide steps featuring anti-skid nosings.
- Grabrails on each side, with a swing gate at the entry point.
- Spigot-mounted, removable guardrail frames on all sides

500kg
WLL

Complies with
Canadian OH&S

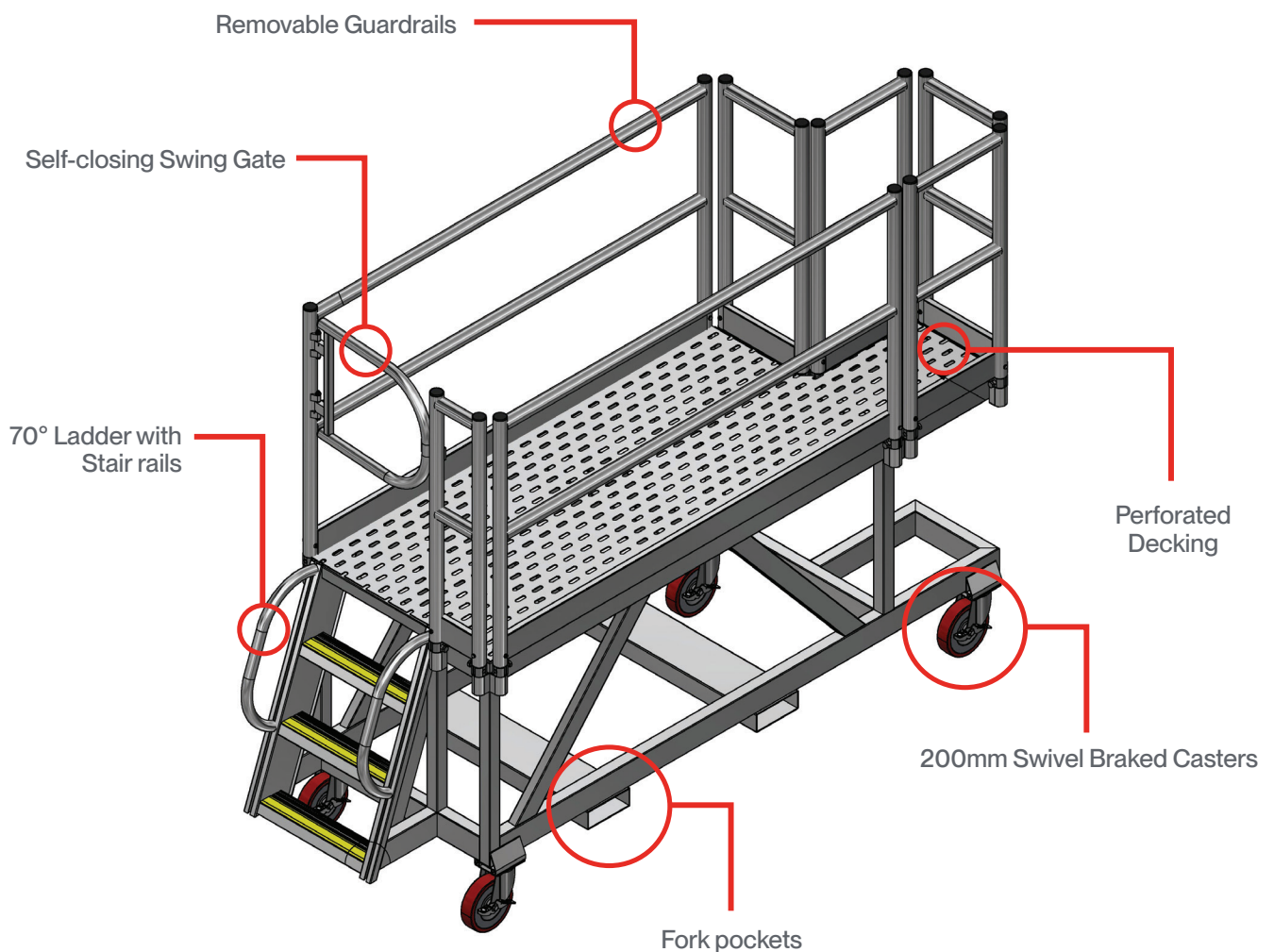
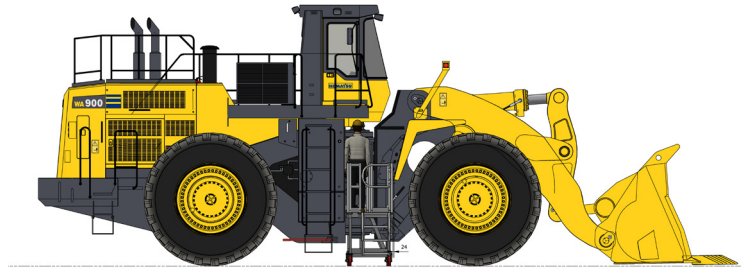

02 Open Pit

Bucket Access Platform

- Platform dimensions: 4.9mL x 2.3mW x 1.2mH (*width includes a 0.8mL clear cantilever to the RHS*).
- Spigot-mounted, removable guardrail, midrail, and toeboard frames on all sides. Leading edge includes seven 0.7m wide removable sections.
- 1.4 m W stairway at a 45° slope, with griptread extrusion steps featuring anti-skid nosings.
- Perforated and swaged material for drainage and safety.

500kg
WLL

Complies with
Canadian OH&S

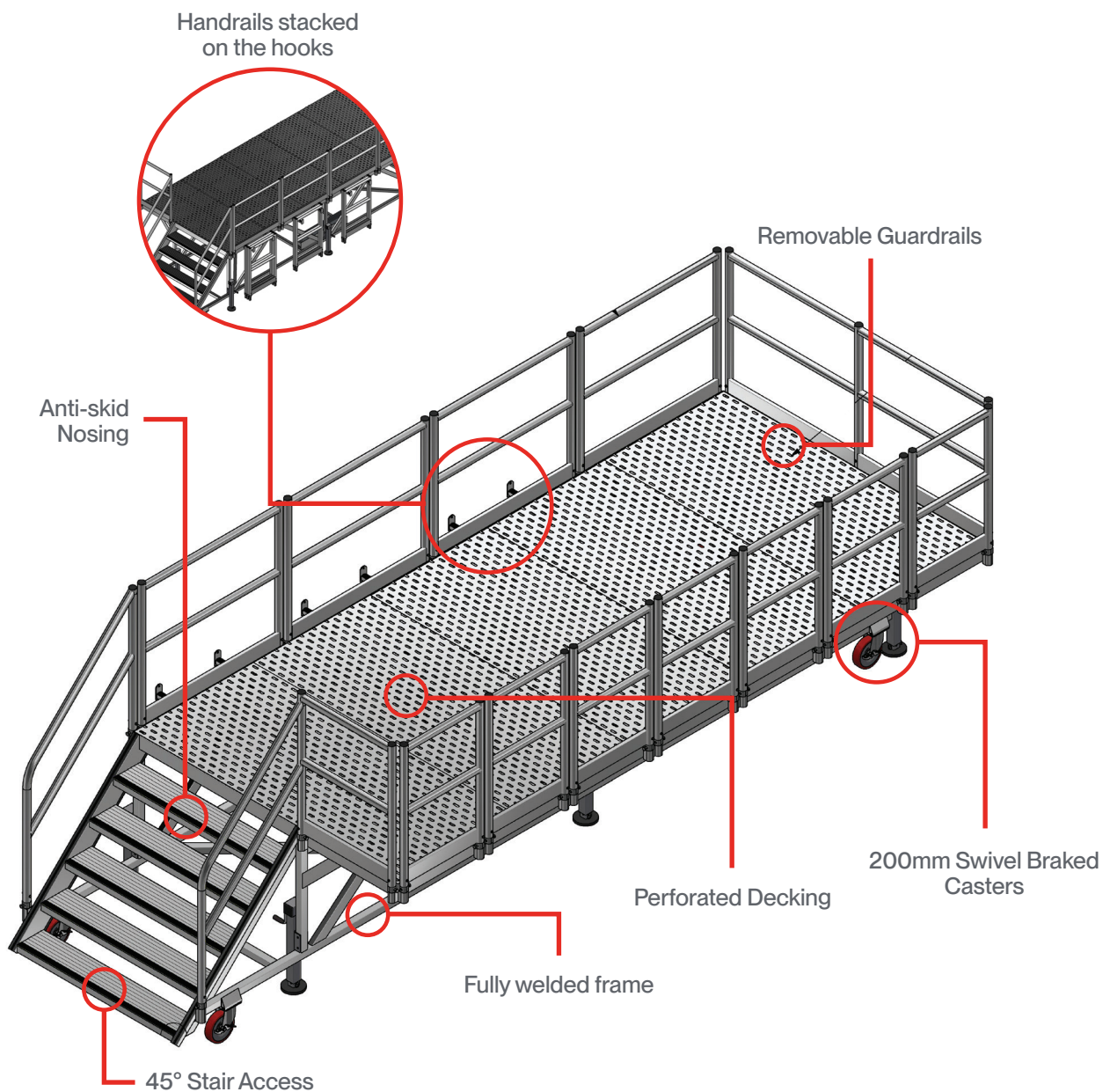



INDUSTRY STORY

BHP - Bowen Basin Workshop

The Challenge

BHP's mining workshops relied heavily on traditional scaffolding for maintenance—an approach that was slow, labour-intensive, and costly. The scaffolding process required large crews to assemble and dismantle structures for each task, causing delays, high labour costs, and storage challenges, all while working in a high-risk, efficiency-driven mining environment.

The Solution

To improve efficiency and reduce dependence on scaffolding, BHP engaged SafeSmart to conduct a detailed scaffolding reduction audit. Based on this, they introduced lightweight, mobile trailer-mounted access platforms constructed from high-strength aluminum. These platforms are height-adjustable, easy to move, and versatile enough to service a wide range of heavy machinery, allowing mechanics to operate independently without waiting on scaffold crews. SafeSmart also provided comprehensive training and ongoing maintenance support to ensure seamless adoption and sustained performance of the new system.



The Result

By replacing traditional scaffolding with mobile access platforms, BHP significantly reduced setup times from over three hours to mere minutes, cutting labour costs and eliminating delays. The new system enhanced safety by minimising the need for scaffold crews and streamlined maintenance workflows, allowing workshop teams to focus more on their core tasks. Today, scaffolding is reserved for large shutdowns and capital projects, while mobile platforms handle daily maintenance—resulting in improved operational efficiency, lower costs, and a safer working environment. This transformation has positioned BHP as a leader in smart mining maintenance solutions.



Section 03

Underground Solutions

Loader Access

Loader Access Platform	55
Loader Access Platform - Rear	56
Accumulator Access LH & RH	57
Tray Access Platform	58
Loader Tilt Cylinder Platform	59
Multi-Purpose Height Adjustable Mining Platform	60
Scaffolding Solutions	61

A Better Way

03 Underground Loader Access Platform

- Compact design for underground workshops, with end platforms nesting inside the side platform frame for easy storage.
- Side platforms wrap around the front wheels of the loader.
- End platforms fit neatly under the bucket when raised.

225kg
WLL

Complies with
Canadian OH&S

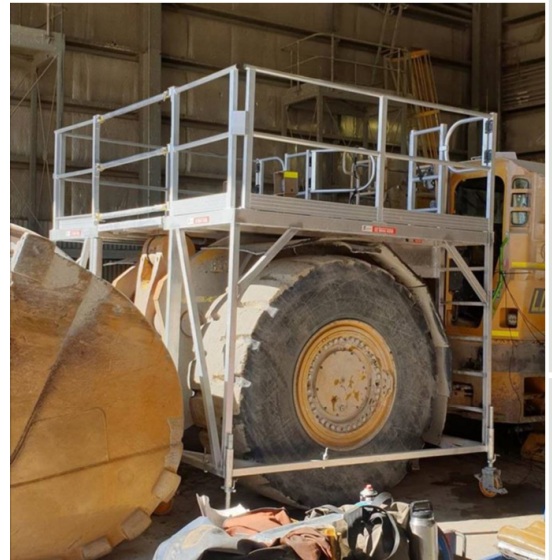

Swing Gates

Adjustable Guardrail at one end with D-pins to lock in place

Quick Release Straps

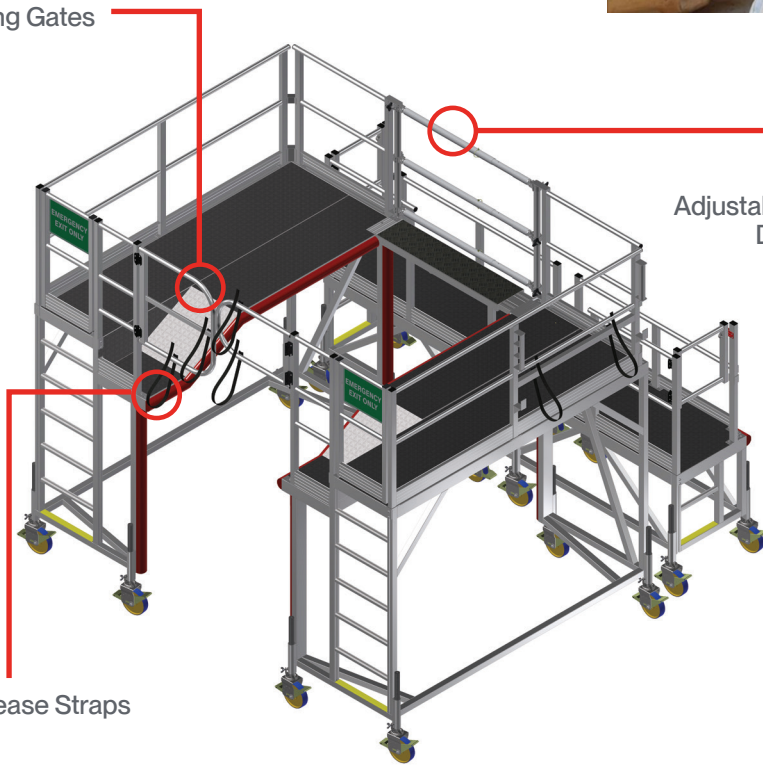

Side Platform

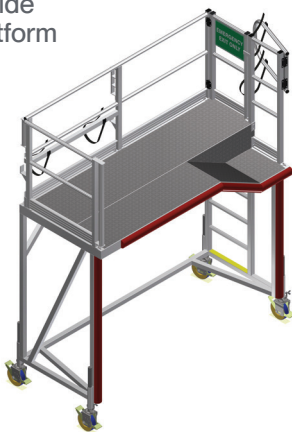

End Platforms (Joined)

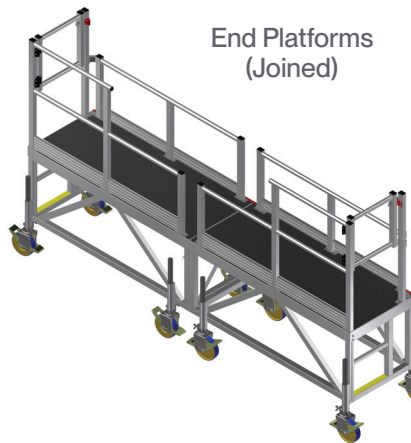

Platforms Stored

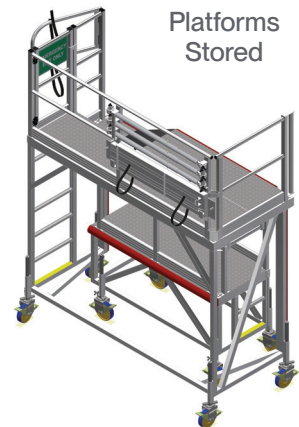

03 Underground

Loader Access Platform - Rear

- Configurable platforms to suit different machines — simply add platform segments to adapt to various types of equipment.
- Provides a full wrap-around solution at the rear of the loader.
- Ideal for heavy maintenance tasks.

225kg
WLL

Complies with
Canadian OH&S

Loader Platform
- Sandvik 621
configuration

Loader Platform
- Sandvik 517
configuration

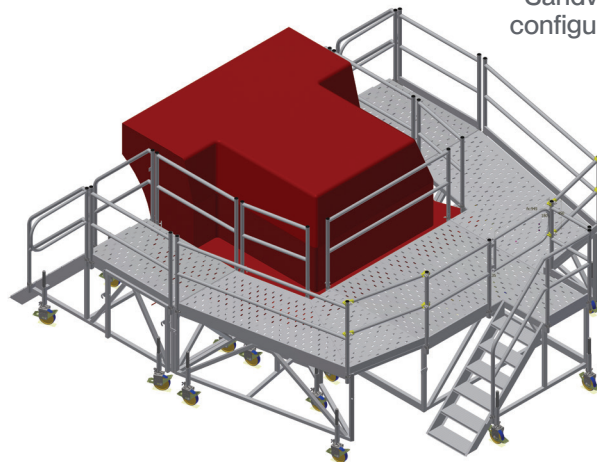
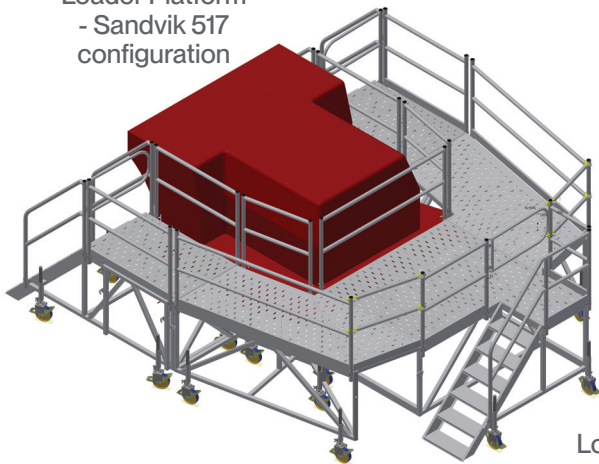

Loader Platform
- CAT R3000H
configuration

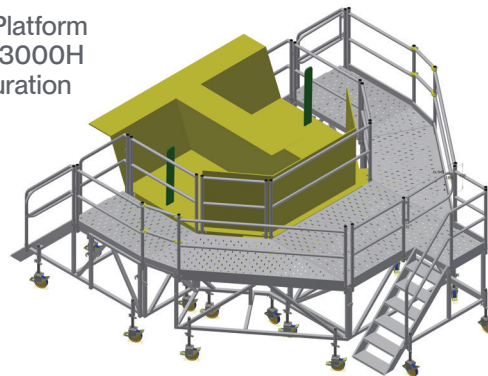

Side Platform
segment

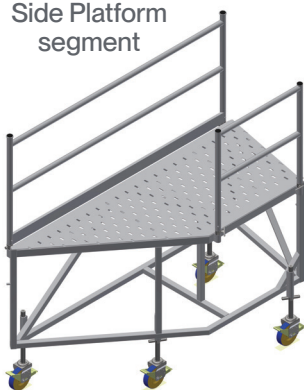

Stair access
module



03 Underground

Accumulator Access LH & RH

- Platform dimensions: 3.85mL x 1.0mW x 2.2mH (*length includes a 1.2mL cantilever*).
- Base rails are set back slightly to create a 0.5 m clear cantilever section.
- LH & RH access platforms are designed to form a bridge configuration; platforms can also be used as standalone units.
- Stairway access at a 45° slope, with griptread extrusion steps and anti-skid nosings, and handrail and midrail on each side.
- Perforated and swaged decking material for safety and drainage.

225kg
WLL

Complies with
Canadian OH&S

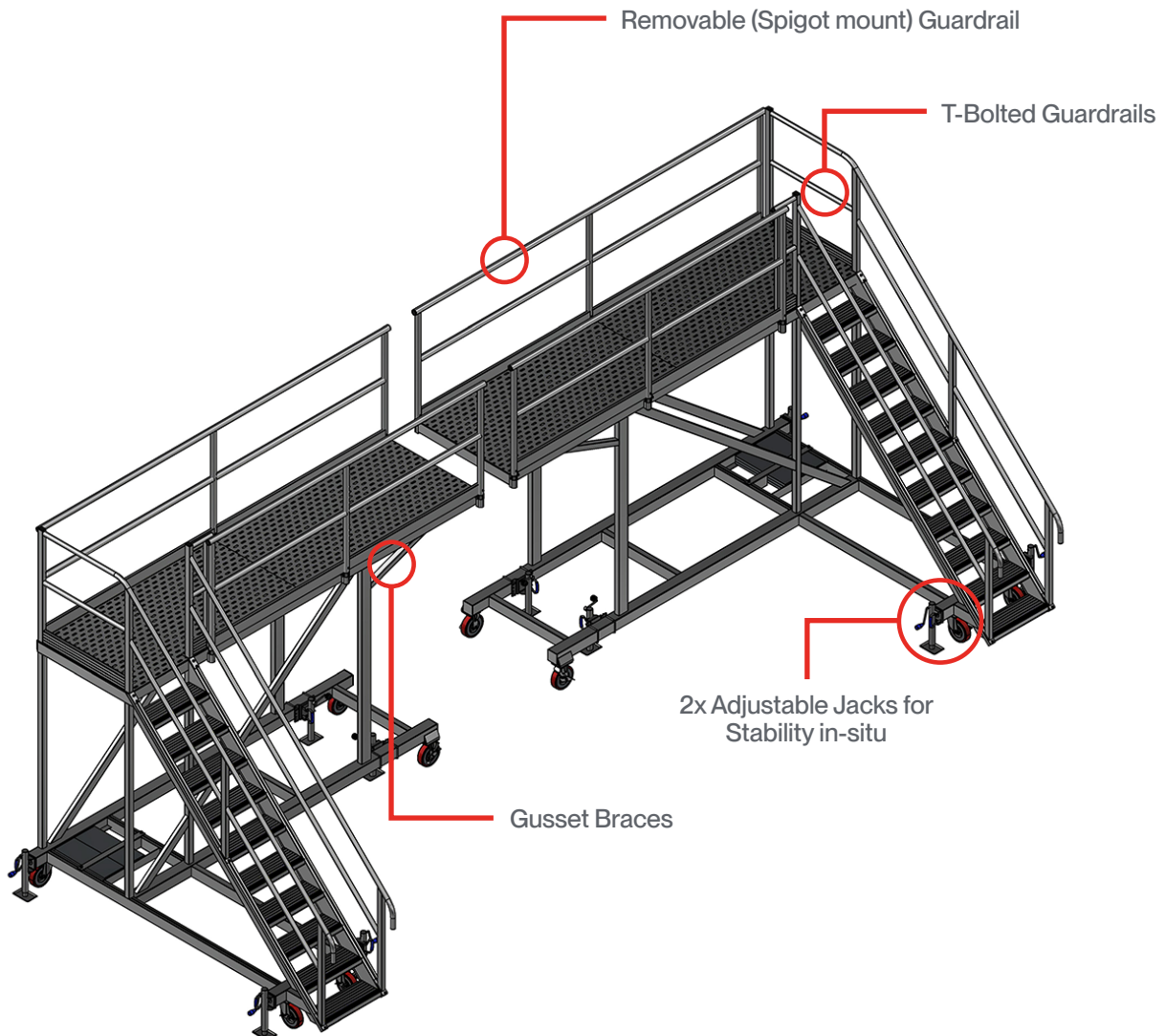

03 Underground Tray Access Platform

- Platform dimensions; 3.1mL x 2.1mW x 2.5mH (length includes a 375mm supported cantilever to the leading edge).
- Parallel stairway access at a 45° slope, with griptread extrusion steps featuring anti-skid nosings.
- Guardrail, midrail, and toeboard frames on all sides, with 1.54 m hinging wings on the leading edge.
- Perforated and swaged decking material for drainage and safety.

225kg
WLL

Complies with
Canadian OH&S

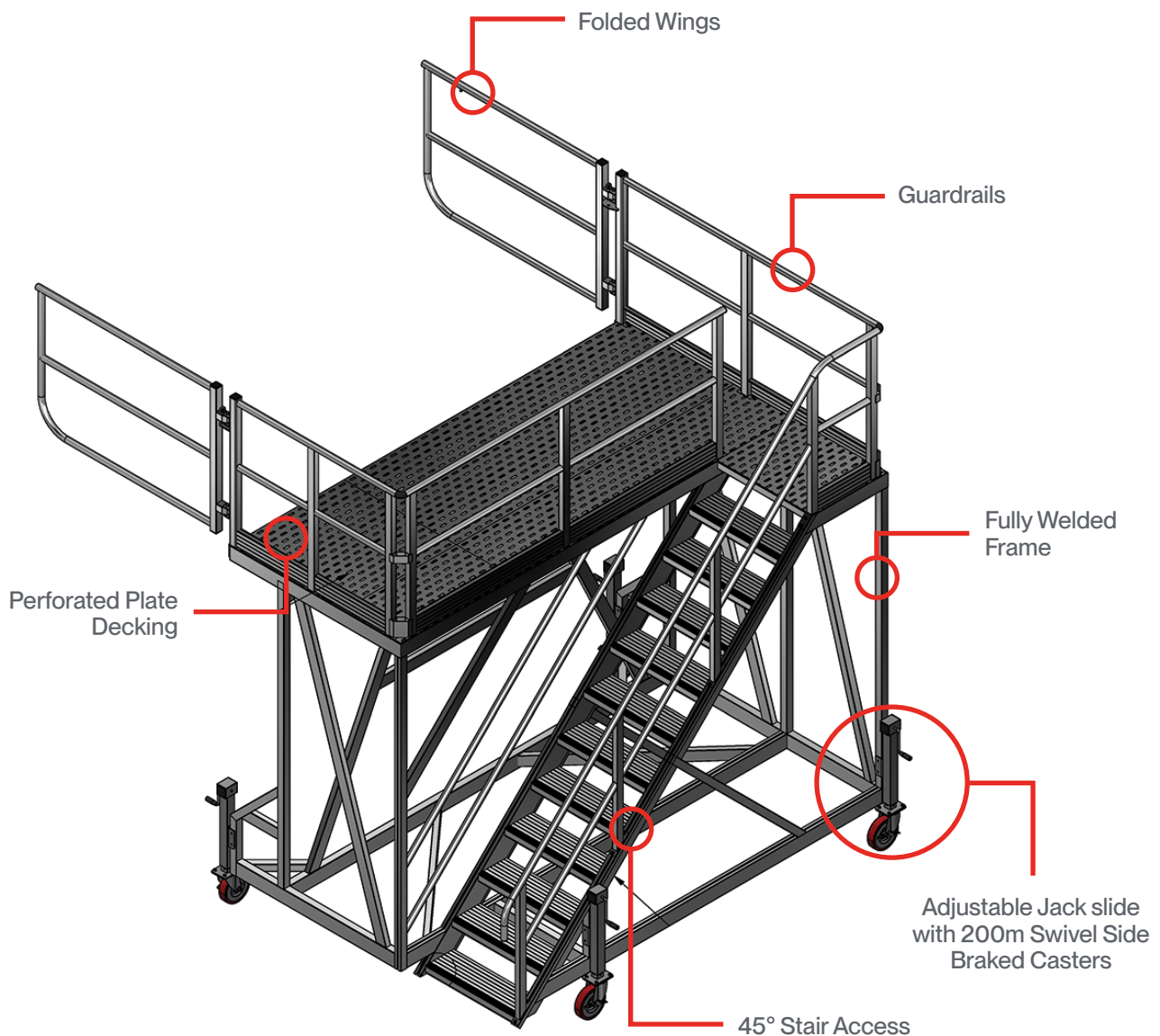

03 Underground Loader Tilt Cylinder Platform

- Platform dimensions: 3mL x 1.7mw x 3.4mH
- U-shaped design fits over the wheel without interference.
- 45° stair access allows safe transport of tools and materials up and down.
- Quick-release handrails at the front provide easy access to the work area.
- Self-draining, slip-resistant perforated aluminum decking.
- Constructed from marine-grade aluminum for long-lasting durability.
- Can be crane lifted or forklifted around site for easy relocation.



225kg
WLL

Complies with
Canadian OH&S



03 Underground

Multi-Purpose Height-Adjustable Mining Platform

- Platform dimensions: 2.3mL x 1.2mW
- Constructed from high-tensile, T6 marine-grade box-section aluminum for ultimate strength and durability.
- Height adjustable via manual winch, ranging from 2.3mH - 3.5mH
- 636mm cantilever overhang for close proximity to the work area.
- Large, safe work area with a self-closing gate providing full surround protection.
- Wind-down jacks for stability and levelling.
- Lifting lugs and fork sleeves for easy on-site mobility.

225kg
WLL

Complies with
Canadian OH&S

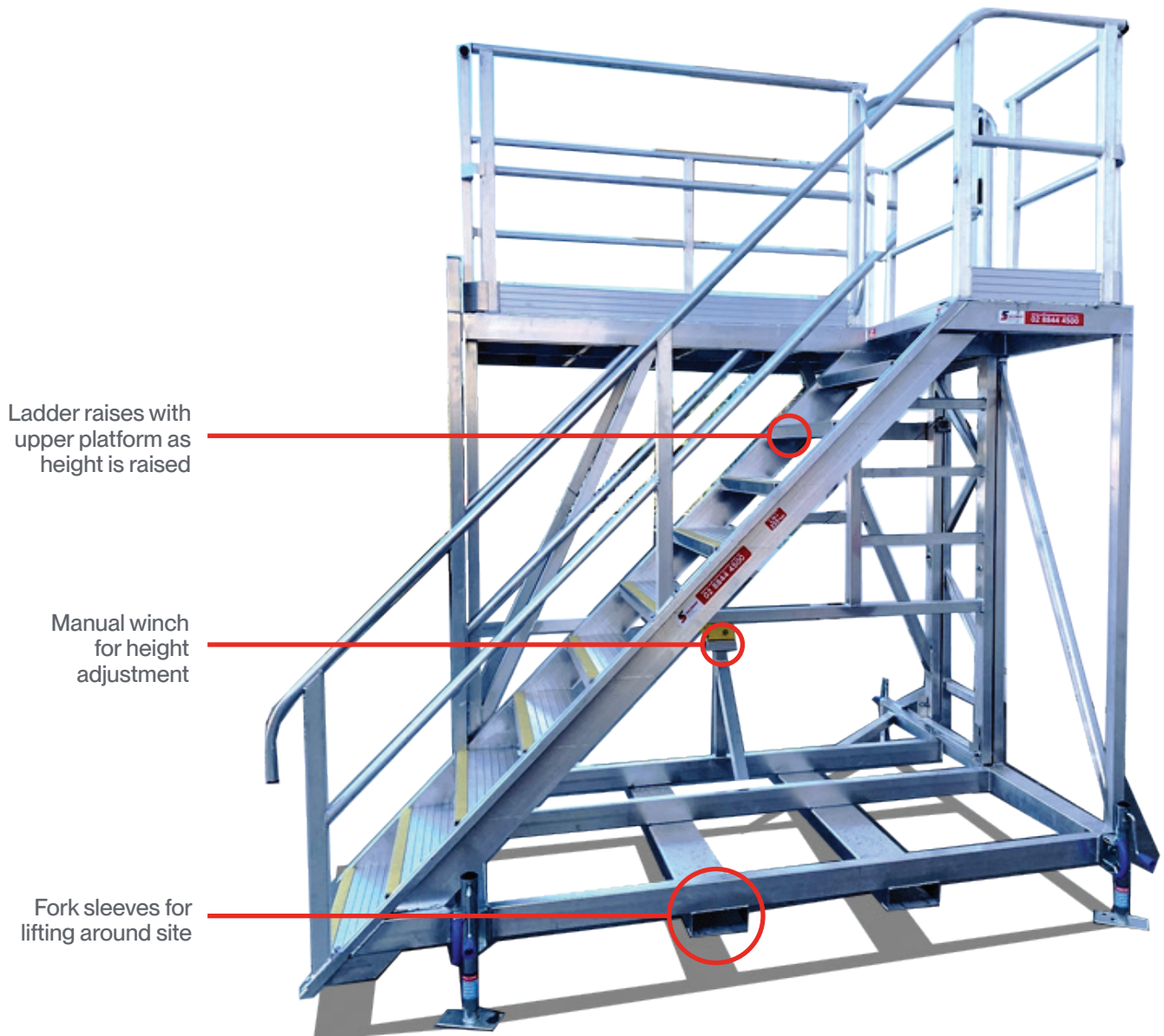



Section 04

Plant Maintenance

Work Platforms & Edge Protection

SafeLoader Platform	62
Aluminum Truck Edge Protection	65
AdjustaStairs	66
SmartStairs/Z-Stack Modular Stair Tower	67
 ProScaf	69
AdaptaStep	71
Modular StepOver 0.8mW	73
Modular StepOver 1.2mW	75
Modular StepOver 0.8mW Accessories	77

A Better Way

04 Plant Maintenance

SafeLoader Platform

Code	Platform Dimensions - Description
210808	0.7mW x 1.4mH x 2.0mL Platform, Stairs one end
210784	0.7mW x 1.4mH x 4.0mL Platform, Stairs one end
210785	0.7mW x 1.4mH x 6.0mL Platform, Stairs one end
210983	1.1mW x 1.4mH x 2.0mL Platform, Stairs one end
210984	1.1mW x 1.4mH x 4.0mL Platform, Stairs one end
210985	1.1mW x 1.4mH x 6.0mL Platform, Stairs one end

- Comes standard with crane lifting points.
- Bolt-on forklifting channels available (ref. pg 28).
- Fully cross braced aluminum frame for a rigid platform.
- Self-closing gate at entrance to platform, as per Canadian OH&S.
- 200mm heavy-duty casters, swivel & locking.
- Originally designed for easy loading & unloading of trucks. Also compatible with a variety of heavy-duty vehicles, mining machinery and trains for loading and maintenance.

2.0mL
500kg
WLL

4.0mL & 6.0mL
1000kg
WLL

Complies with
Canadian OH&S

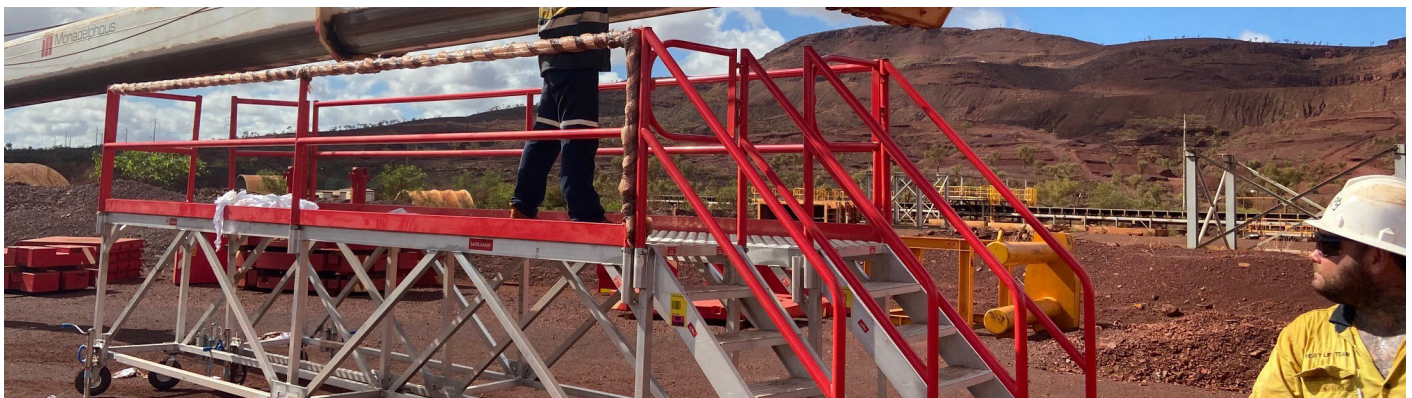

Place in position & lock casters



Enter through the gate and onto the deck



Safely Load & Unload



04 Plant Maintenance SafeLoader Platform

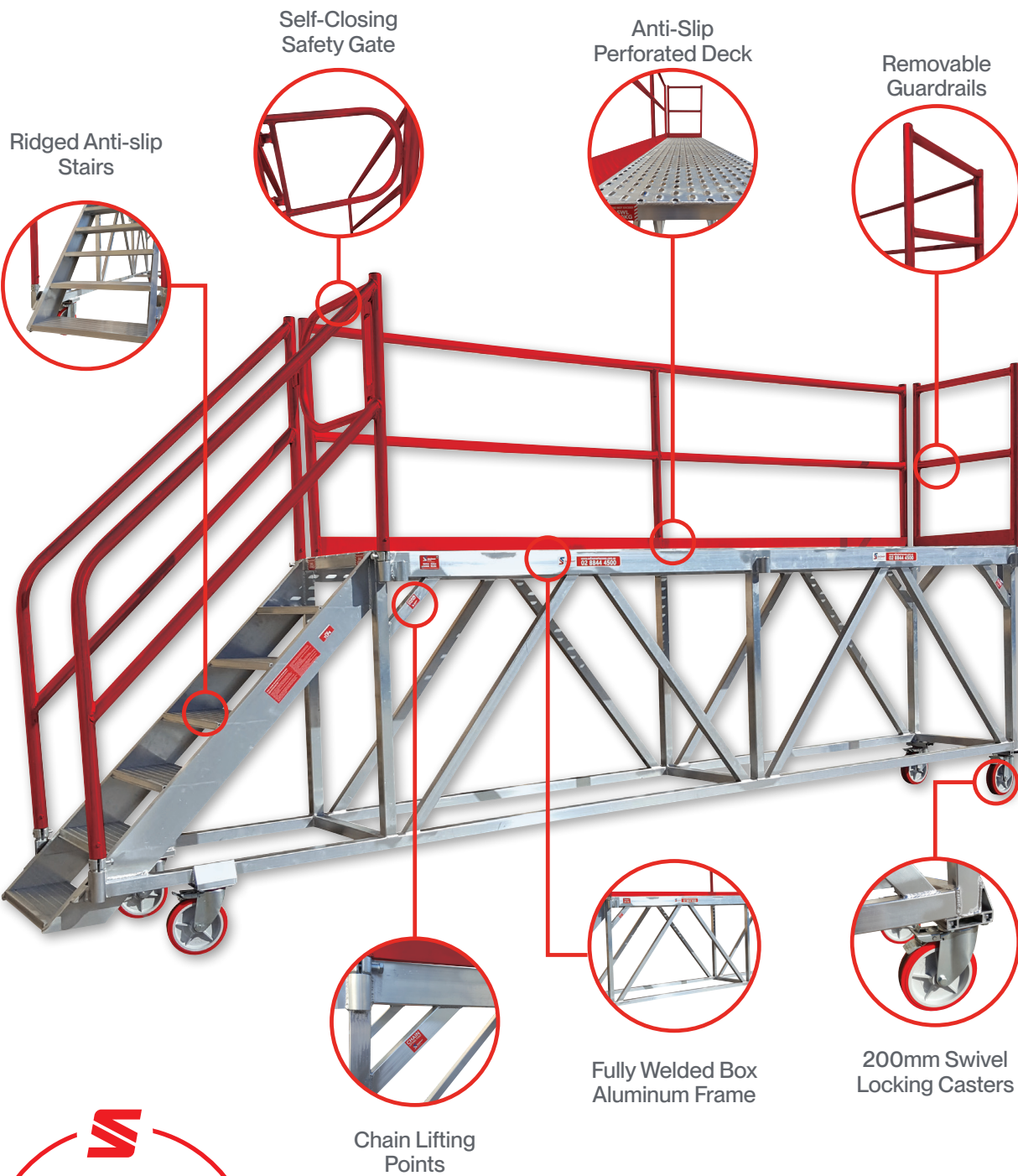

Platforms Available
in 700mm &
1100mm Widths

04 Plant Maintenance

SafeLoader Platform - Accessories

SafeLoader Casters & Adjustable Jacks

Code	Description
210787	SafeLoader Foam Filled Caster Retrofit
210807	SafeLoader 260mm Solid Rubber Caster & Jack Retrofit Kit

- Upgrade from the standard 200mm locking casters.
- Ideal for rough terrain & uneven surfaces.
- Puncture-proof solid rubber wheels.

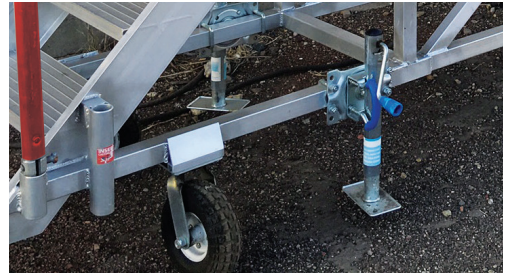

SafeLoader Joining Kit

Code	Description
210193	SafeLoader Joining Kit
210664	6mL SafeLoader Bolted Joining Section (No Casters)

- Used to join two SafeLoaders end-to-end, to create a longer working platform.

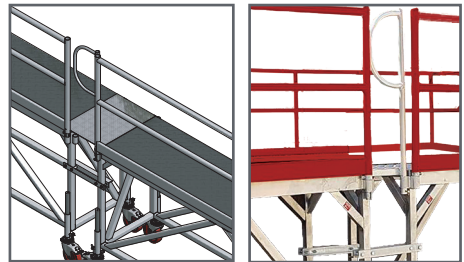

Retrofit Fork Sleeves

Code	Description
210697	Retrofit Fork Sleeves

- Add to any standard SafeLoader for forklift transport around site.
- Simply bolts to SafeLoader structure.



Infill Section

Code	Description
210665	SafeLoader Infill - End Handrail
210666	2mL SafeLoader Wheeled Infill Section
210667	4mL SafeLoader Wheeled Infill Section
210668	6mL SafeLoader Wheeled Infill Section

- SafeLoader infill sections are used to create longer working platforms.
- Connect 2x SafeLoaders (2m, 4m or 6m) with an infill section to obtain platform lengths up to 18m!

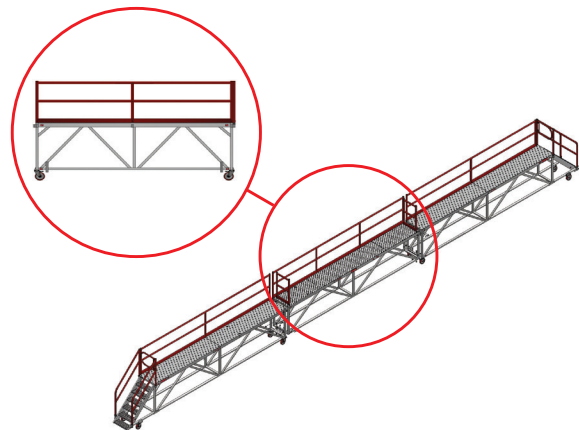

Infill Section

Code	Description
210669	Lever Brake Kit

- Single hand action lever brake.
- Avoid applying brakes to casters individually.



04 Plant Maintenance

Aluminum Edge Protection Panel

Code	Width	Height
210273	4.0m	2.5m
210787	Truck Edge Protection Panel Retrofit All Terrain Wheel	

- Flat packed for storage & transportation.
- Light & easy to use - simply roll up to truck & clip to tie rail.
- Suitable for tray heights up to 1.5m.

Complies with
Canadian OH&S

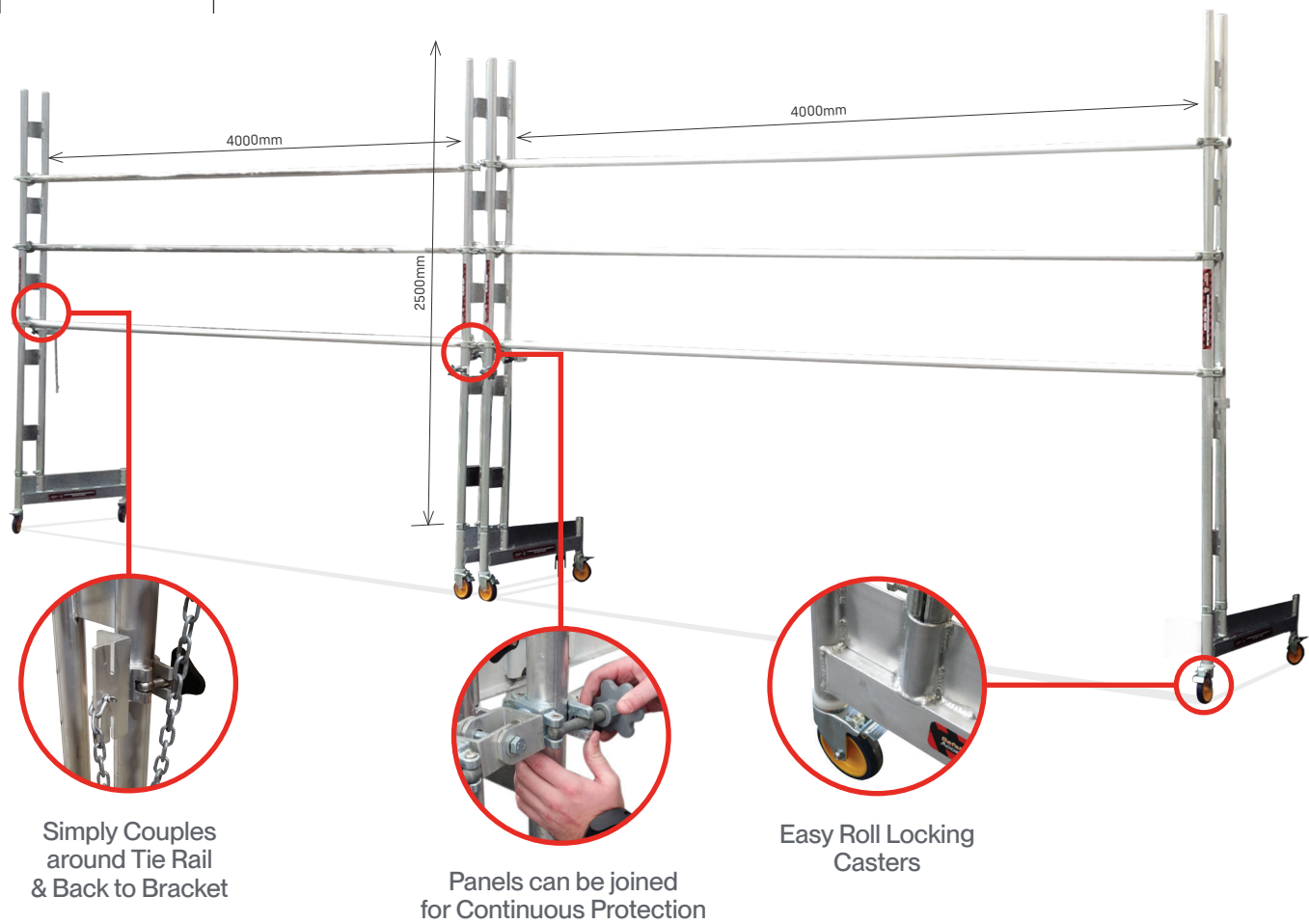

04 Plant Maintenance

AdjustaStairs

600mmW Aluminum (3-18 Steps)

“SafeSmart’s AdjustaStairs are very convenient, very light to use, and very durable. We use these right across the site, SafeSmart all the way!”

— Scaffold Manager, NI1 Construction

Code	Steps	Height Range
210818	3	0.49m - 0.67m
210813	6	0.97m - 1.33m
210814	9	1.43m - 2.0m
210815	12	1.91m - 2.67m
210816	15	2.39m - 3.33m [^]
210817	18	2.87m - 4.0m [^]

[^]Stairs include trussed stringer.

2.5kPa
WLL

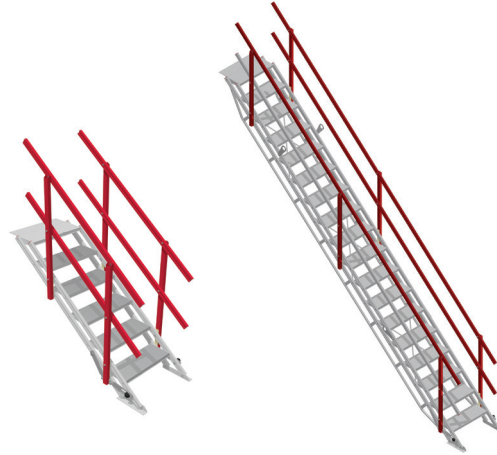

1200mmW Aluminum (3-18 Steps)

Code	Steps	Height Range
210821	3	0.49m - 0.67m
210822	6	0.97m - 1.33m
210823	9	1.43m - 2.0m
210824	12	1.91m - 2.67m [^]
210825*	15	2.39m - 3.33m [^]
210826*	18	2.87m - 4.0m [^]

[^]Stairs include trussed stringer.

2.5kPa
WLL

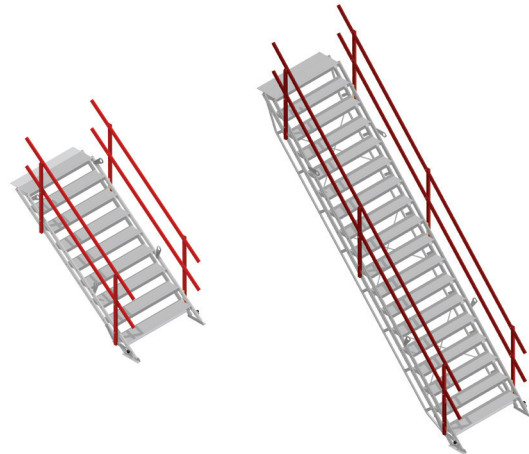

04 Plant Maintenance

SmartStairs/Z-Stack - Steel Modular Stair System

PERFECT FOR ACCESS TO:

- Fixed plant processing areas.
- Reconciliation of Material (ROM) bins.
- Train load out facilities.
- Designed to freestand up to 18m.

2.3mH Stretcher Stair Module Freestanding Series*

Code	Description
221007	Steel Stretcher Stair Module - 2.3mH x 2.86mW x 4.0mL*

2.5kPa
WLL

Complies with
Canadian OH&S

3.0mH
Available upon
request

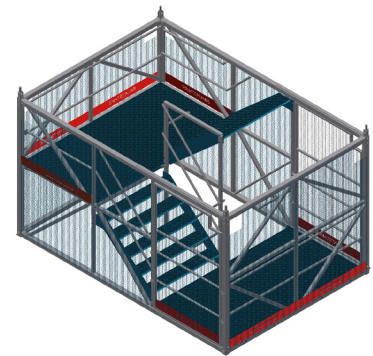

2.3mH Construction Stair Module

Code	Description
221005	Steel Construction Stair Module - 2.3mH x 1.57mW x 2.8mL

2.5kPa
WLL

Complies with
Canadian OH&S

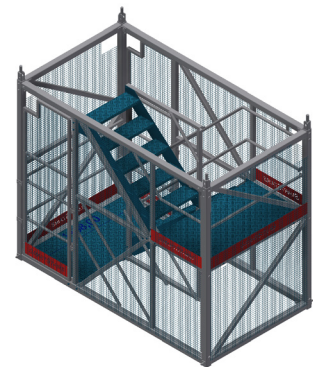

2.3mH SafeRise Ladder Module

Code	Description
221063	Steel Ladder Module - 2.3mH x 0.9mW x 1.82mL

2.5kPa
WLL

Complies with
Canadian OH&S

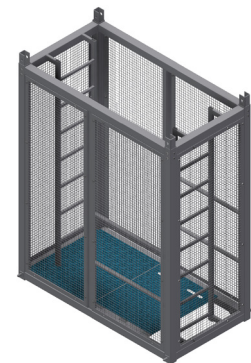

04 Plant Maintenance

SmartStairs/Z-Stack - Steel Modular Stair System



A Better Way



04 Plant Maintenance

The Proscaf Advantage - A Better Way to Operate

Proscaf: Do more with Less. The ring system delivers ultimate flexibility, designed to maximize build efficiency while minimising personnel requirements.

The unconventional becomes conventional: The unique load bearing properties of Proscaf components make it ideal for projects that involving:

- Cantilevered/spurring structures
- Craneable structures
- Heavy-duty loading/propping
- Public access ramps and stairs
- Facade access

Build with Confidence

The system's highly engineered properties, combined with extensive technical data, make the design and construction of complex structures simpler and more efficient.

Extensive QA Processes

Batch testing and stamping of every component help operational teams verify and track any Proscaf equipment they own. Proscaf fully complies with **Canadian OH&S** and is manufactured through our **ISO 9001**-certified production facility.

Expand your options

The Proscaf range includes:

- Components for public access structures such as stairs, ramps, and viewing platforms
- SwiftStage staging system.
- Proscaf Aluminum system range.
- SmartBridge bridging system.
- SmartRoof roofing/encapsulation system.

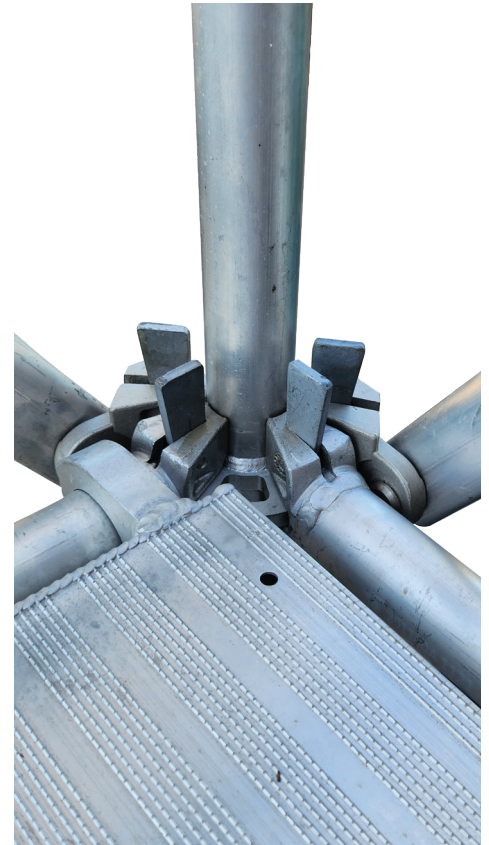

04 Plant Maintenance

Streamline Expenditure, with a Proscaf Partnership

SafeSmart partnered with a major food processing company operating across seven industrial sites with infrastructure over 120 years old. The complexity and age of the facilities required ongoing maintenance and frequent capital upgrade projects, often needing scaffolding.

Traditionally, the company hired scaffolding through contractors, which involved variable costs and frequent misalignments between the project scope and contractor quotes. This often resulted in project delays and unexpected expenses that strained budgets.



To address this, SafeSmart introduced Proscaf—a modular scaffolding system the client could purchase rather than hire. SafeSmart’s design team collaborated closely with the client to develop scaffold designs and build methodologies with fixed costs for materials, providing budget certainty regardless of project duration.

By investing in Proscaf materials upfront, the client transformed scaffolding into a reusable asset, reducing dependence on hired equipment. Scaffold contractors were retained solely for installation and dismantling labor, simplifying operations and avoiding the need for stock commitments.

Following the success of the initial project, SafeSmart has continued to support the client with design, material supply, and scaffolding solutions across all seven sites. Over four years, the client’s investment in Proscaf has significantly reduced scaffolding expenses to less than 20% of previous costs, delivering long-term cost savings and improved project efficiency.

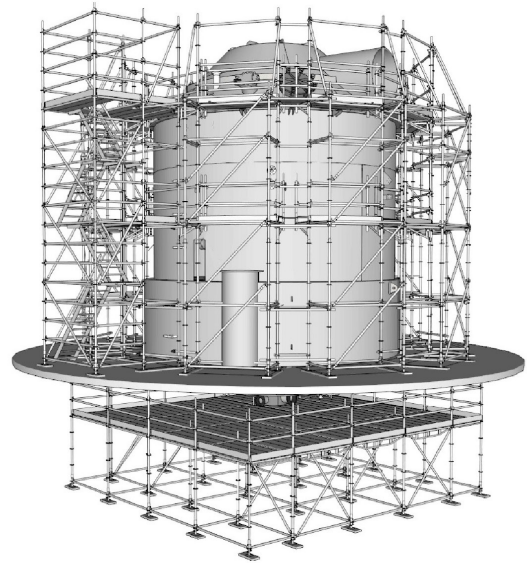

PERSPECTIVE
SCALE NTS

Terms & Conditions

1. Copyright SafeSmart Access 2026. No part of this publication may be reproduced without the written permission of SafeSmart Access.
2. SafeSmart Access has made every effort to portray accurate descriptions and information within this catalogue. No liability is accepted in the event of errors or omissions.
3. Where specifications are provided they are intended as a guide only. Please enquire from our staff for full details of product at time of enquiry.
4. Products may be deleted, amended, substituted or changed at the sole discretion of SafeSmart Access.
5. The customer/user must establish the suitability of the product purchased for their own safe use.
6. Trade Marks. Where any registered trade mark has been used it is with recognition of the owner’s right.
7. Any measurements shown are intended as a guide only. Please confirm any critical measurement with SafeSmart Access.
8. Compliance to standards may be in part or whole subject to the nature of the product.



04 Plant Maintenance

AdaptaStep

- Platforms available in 9 1/2" increments dictated by the width of the extruded aluminum deck material
- Constructed from high-tensile T6 aluminum, for rough site conditions
- Supplied disassembled (where required) for ease of installation in tight locations
- Custom size options are also available



04 Plant Maintenance

AdaptaStep - Key Features

- Platform and step extrusions
- Structural support extrusion
- Pre-formed powder coated handrail panels
- Stair mounting plate
- Connection elements
- Thread forming, high-tensile screws
- Tee bolts



04 Plant Maintenance

Modular StepOver Platforms 0.8mW - Components

Choose your step angle, height and bridge length to build a premium grade step over platform.

Built tough with features such as a box section high tensile aluminum frame, and perforated plate deck surfaces. Supplied disassembled for ease of installation in tight locations.

225kg
WLL

Complies with
Canadian OH&S

5 Year
Warranty

70° Ladder 0.8mW Range

Code	Description	Platform Height
210700	Stepover 2 Step Ladder & Handrails	560mm
210701	Stepover 3 Step Ladder & Handrails	850mm
210702	Stepover 4 Step Ladder & Handrails	1120mm
210703	Stepover 5 Step Ladder & Handrails	1400mm
210704	Stepover 6 Step Ladder & Handrails	1700mm
210646	Stepover 7 Step Ladder & Handrails	1970mm
210647	Stepover 8 Step Ladder & Handrails	2200mm
210648	Stepover 9 Step Ladder & Handrails	2550mm



- Standard step height is 280mm, standard angle of ladder slope is 70-degrees, standard ladder width is 800mm.
- Standard ladder has rubber feet which can be changed for retrofit permanent feet plates which will attach to the support surface.
- Includes two ladder handrails which attach to the ladder stile and the main platform handrail posts.

45° Stair 0.8mW Range

Code	Description	Platform Height
210736	Stepover Stair & Handrails	373mm
210737	Stepover Stair & Handrails	560mm
210738	Stepover Stair & Handrails	850mm
210739	Stepover Stair & Handrails	1120mm
210740	Stepover Stair & Handrails	1266mm
210741	Stepover Stair & Handrails	1400mm
210742	Stepover Stair & Handrails	1692mm
210640	Stepover Stair & Handrails	1970mm
210643	Stepover Stair Brace to suit 1970mmH Platform with 45-degree stairs	-
210641	Stepover Stair & Handrails	2200mm
210644	Stepover Stair Brace to suit 2200mmH Platform with 45-degree stairs	-
210642	Stepover Stair & Handrails	2550mm
210645	Stepover Stair Brace to suit 2550mmH Platform with 45-degree stairs	-



StepOver Stair Brace Example

- 220mm deep stair treads for comfortable access to the platform.
- Stair treads are ridged for safety and grip in all site conditions.
- Available as standard with bolt-down feet.

04 Plant Maintenance

Modular StepOver Platforms 0.8mW - Components

Platform Bridge 0.8mW Range

Code	Description
210143	Stepover Platform Bridge 0.6mL x 0.8mW
210706	Stepover Platform Bridge 1.0mL x 0.8mW
210707	Stepover Platform Bridge 1.5mL x 0.8mW
210708	Stepover Platform Bridge 2.0mL x 0.8mW
210786	Stepover Platform Bridge 3.0mL x 0.8mW
210140	Stepover Platform Bridge 4.0mL x 0.8mW
210141	Stepover Platform Bridge 6.0mL x 0.8mW

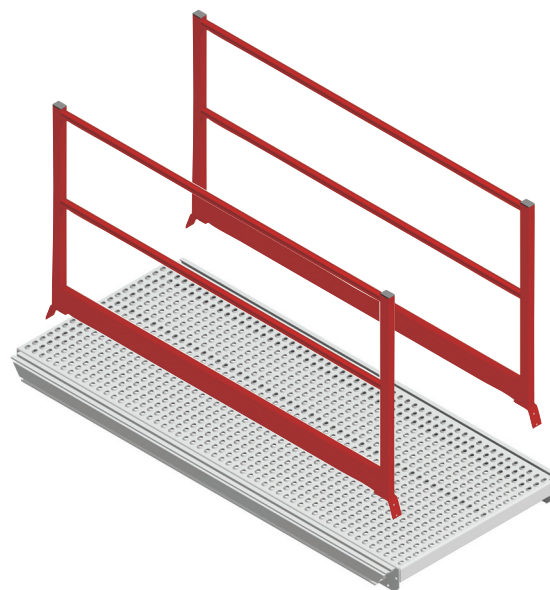

- The platform decks are perforated and swaged plate.
- Platforms bolt to a step ladder at each end.
- Ladder sizes are interchangeable.
- The handrail set includes two frames, one for each side, which are bolted to the platform.
- There is a guardrail, midrail and toeboard for each frame.
- Can be used independently as an access bridge.

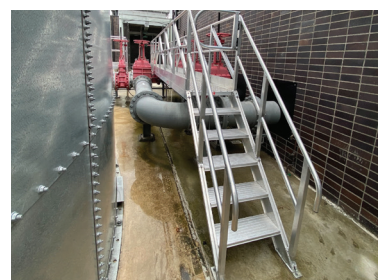

Vertical Ladder 0.8mW Range

Code	Description	Platform Height
210731	Stepover 2 Step Vertical Ladder	560mm
210732	Stepover 3 Step Vertical Ladder	850mm
210733	Stepover 4 Step Vertical Ladder	1120mm
210734	Stepover 5 Step Vertical Ladder	1400mm
210735	Stepover 6 Step Vertical Ladder	1700mm
210649	Stepover 7 Step Vertical Ladder	1970mm
210650	Stepover 8 Step Vertical Ladder	2200mm
210651	Stepover 9 Step Vertical Ladder	2550mm

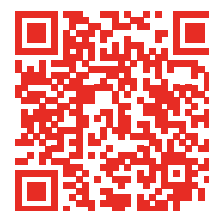
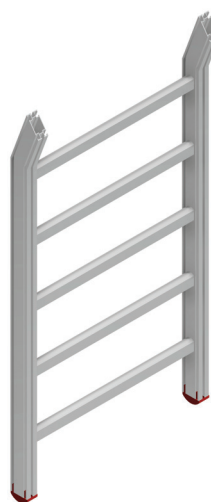

SCAN CODE
TO VIEW
VIDEO

- Width of the ladder is 800mm.
- Vertical ladder with 280mm step spacing and a 90° slope.
- Rubber feet can be changed for retrofit permanent feet plates which will attach to the support surface.
- The top of the vertical ladder stiles is angled to match the standard platform bridge.



04 Plant Maintenance

Modular StepOver Platforms 1.2mW - Components

Choose your step angle, height and bridge length to build a premium grade step over platform.

Built tough with features such as a box section high tensile aluminum frame, and perforated plate deck surfaces. Supplied disassembled for ease of installation in tight locations.

225kg
WLL

Complies with
Canadian OH&S

5 Year
Warranty

Platform Bridge 1.2mW Range

Code	Description
240020	Stepover Platform Bridge 0.6mL x 1.2mW
240021	Stepover Platform Bridge 1.0mL x 1.2mW
240022	Stepover Platform Bridge 1.5mL x 1.2mW
240023	Stepover Platform Bridge 2.0mL x 1.2mW
240024	Stepover Platform Bridge 3.0mL x 1.2mW

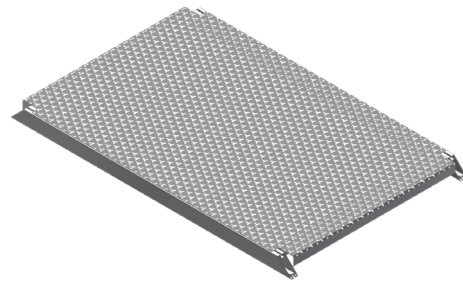

- The platform decks are perforated and swaged plate.
- Platforms bolt to a step ladder at each end.
- Can be used independently as an access bridge.

Platform Bridge Handrails 1.2mW Range - Standard

Code	Description	Handrail Height
240025	Platform Handrail Pair Only 0.6mL x 1.2mW	1000mm
240026	Platform Handrail Pair Only 1.0mL x 1.2mW	1000mm
240027	Platform Handrail Pair Only 1.5mL x 1.2mW	1000mm
240028	Platform Handrail Pair Only 2.0mL x 1.2mW	1000mm
240029	Platform Handrail Pair Only 3.0mL x 1.2mW	1000mm

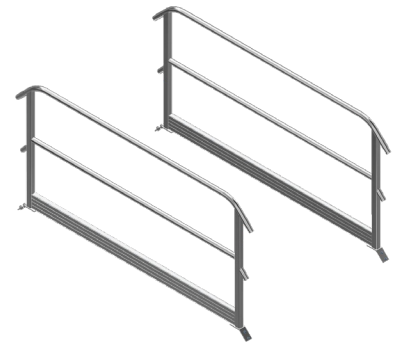

- Ladder sizes are interchangeable.
- The handrail set includes two frames, one for each side, which are bolted to the platform.
- There is a guardrail, midrail and toeboard for each frame.

Platform Bridge Handrails 1.2mW Range - Stretcher

Code	Description	Handrail Height
240030	Platform Handrail Pair Only 0.6mL x 1.2mW (Stretcher Height)	1400mm
240031	Platform Handrail Pair Only 1.0mL x 1.2mW (Stretcher Height)	1400mm
240032	Platform Handrail Pair Only 1.5mL x 1.2mW (Stretcher Height)	1400mm
240033	Platform Handrail Pair Only 2.0mL x 1.2mW (Stretcher Height)	1400mm
240034	Platform Handrail Pair Only 3.0mL x 1.2mW (Stretcher Height)	1400mm

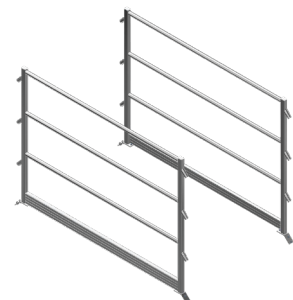

04 Plant Maintenance

Modular StepOver Platforms 1.2mW - Components

45° Stair 1.2mW Range

Code	Description	Platform Height
240001	StepOver 2 Step Stair Only - 1.2mW	450mm
240002	StepOver 3 Step Stair Only - 1.2mW	675mm
240003	StepOver 4 Step Stair Only - 1.2mW	900mm
240004	StepOver 5 Step Stair Only - 1.2mW	1125mm
240005	StepOver 6 Step Stair Only - 1.2mW	1350mm
240006	StepOver 7 Step Stair Only - 1.2mW	1575mm
240007	StepOver 8 Step Stair Only - 1.2mW	1800mm
240008	StepOver 9 Step Stair Only - 1.2mW	2025mm
240009	StepOver 10 Step Stair Only - 1.2mW	2250mm
240010	StepOver 11 Step Stair Only - 1.2mW	2475mm

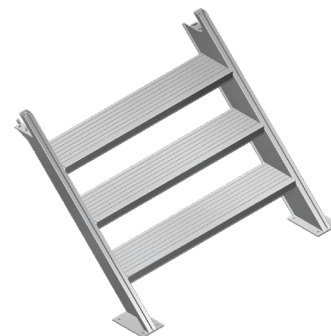

- 220mm deep stair treads for comfortable access to the platform.
- Stair treads are ridged for safety and grip in all site conditions.
- Available as standard with bolt-down feet.

45° Handrails 1.2mW Range - Standard

Code	Description	Platform Height
240011	StepOver 2 Step Handrail Pair Only - 1.2mW	1000mm
240012	StepOver 3 Step Handrail Pair Only - 1.2mW	1000mm
240013	StepOver 4 Step Handrail Pair Only - 1.2mW	1000mm
240014	StepOver 5 Step Handrail Pair Only - 1.2mW	1000mm
240015	StepOver 6 Step Handrail Pair Only - 1.2mW	1000mm
240016	StepOver 7 Step Handrail Pair Only - 1.2mW	1000mm
240017	StepOver 8 Step Handrail Pair Only - 1.2mW	1000mm
240018	StepOver 9 Step Handrail Pair Only - 1.2mW	1000mm
240019	StepOver 10 Step Handrail Pair Only - 1.2mW	1000mm
240035	StepOver 11 Step Handrail Pair Only - 1.2mW	1000mm

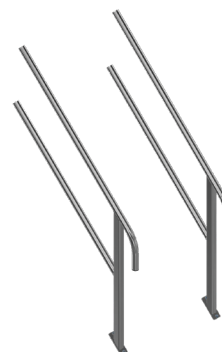

45° Handrails 1.2mW Range - Stretcher

Code	Description	Platform Height
240036	StepOver 2 Step Handrail Pair Only (Stretcher Height) - 1.2mW	1400mm
240037	StepOver 2 Step Handrail Pair Only (Stretcher Height) - 1.2mW	1400mm
240038	StepOver 2 Step Handrail Pair Only (Stretcher Height) - 1.2mW	1400mm
240039	StepOver 2 Step Handrail Pair Only (Stretcher Height) - 1.2mW	1400mm
240040	StepOver 2 Step Handrail Pair Only (Stretcher Height) - 1.2mW	1400mm
240041	StepOver 2 Step Handrail Pair Only (Stretcher Height) - 1.2mW	1400mm
240042	StepOver 2 Step Handrail Pair Only (Stretcher Height) - 1.2mW	1400mm
240043	StepOver 2 Step Handrail Pair Only (Stretcher Height) - 1.2mW	1400mm
240044	StepOver 2 Step Handrail Pair Only (Stretcher Height) - 1.2mW	1400mm
240045	StepOver 2 Step Handrail Pair Only (Stretcher Height) - 1.2mW	1400mm

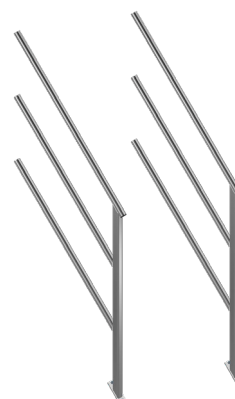

04 Plant Maintenance

Modular StepOver Platforms 0.8mW - Accessories

Code	Description
210142	Modular Short Leg (ea.)
210705	Permanent Base Plate Set to suit 70° Ladder. Set of two brackets.
210709	Permanent Base Plate set to suit Vertical Ladder (Set of two)
210144	Lifting Lug Angled - incl. Hardware (ea.)
210630	Modular Stepover Retrofit Wheel Kit Bracket
230235	Heavy-Duty Adjustable Height Caster-200mm, 700kg WLL
210681	Fixed Bolt-in End Panel (1.0mH x 0.9mW)
210899	Batwing Gates 400mmW to suit Modular StepOver 900mmW
210788	70° Ladder Brace
210789	90° Ladder Brace

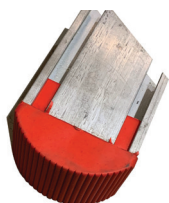

210142
Modular Short Leg

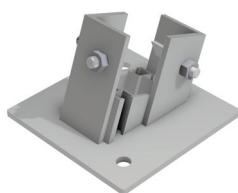

210705
Permanent Base Plate Set

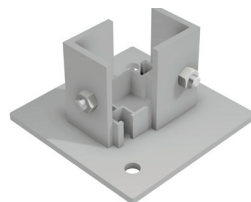

210709
Permanent Base Plate Set
(Vertical Ladder)



210144
Lifting Lug Angled
(Includes Hardware)

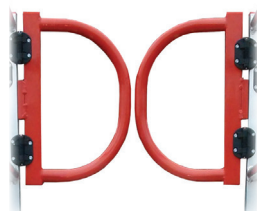

210899
Batwing Gates

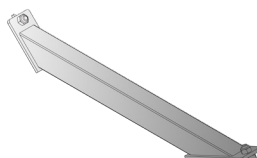

210788
70° Ladder Brace



210789
90° Ladder Brace

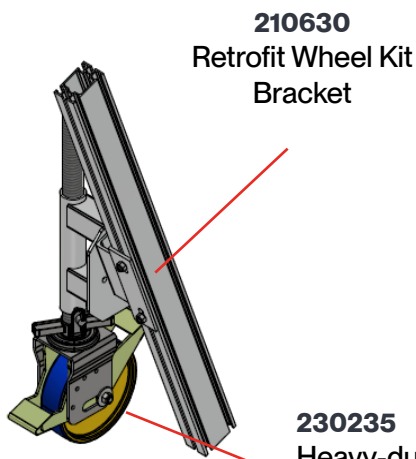

210630
Retrofit Wheel Kit
Bracket

230235
Heavy-duty Adjustable
Height Caster



210681
Fixed Bolt-in
End Panel



Stocked Solutions

Open Pit Solutions

Underground Solutions

Plant Maintenance



A Better Way

Office Locations

Regina
1911 Truesdale Drive
Regina, SK
S4V 0M2

Toronto
470 Industrial Drive
Milton, ON
L9T 5A6

Vancouver
105-3560 190 Street
Surrey, BC
V3Z 0P6